

DIN Adapters

We feel better under pressure

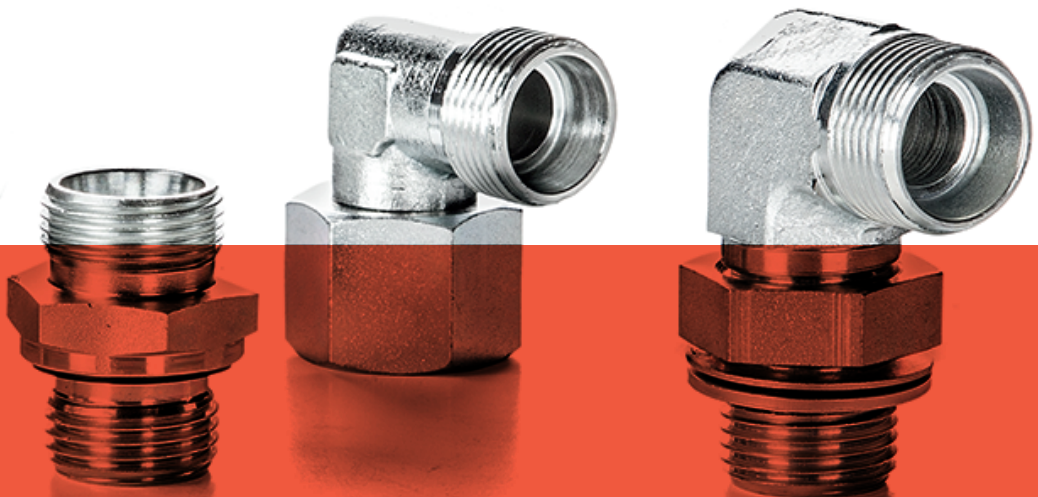

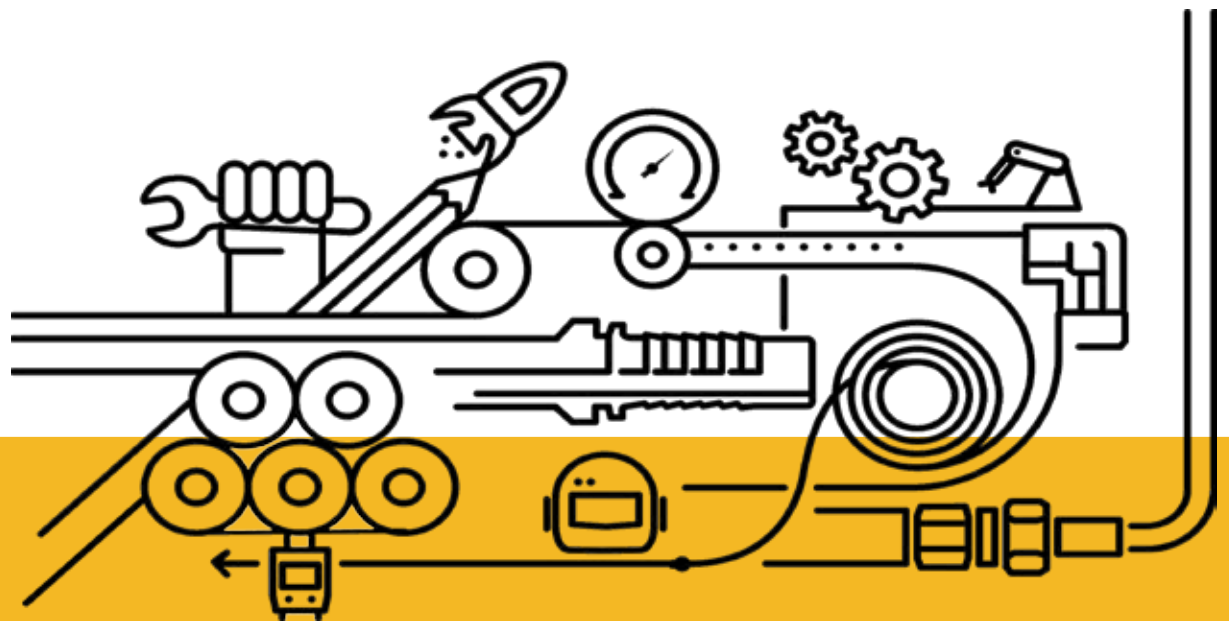

We feel better under pressure

Our strong points

Complete product range

Vitillo is the solution to any problem of hydraulic applications. Spiral and braided hoses with metal reinforcement, standard and interlock press fittings, BSP, JIC, DIN and ORFS adaptors, customized special fittings: Whatever the customer's question, Vitillo is the answer.



Hoses



Press fittings
ISO 12151 SAE J516



BSP adaptors
BS 5200



JIC adaptors
SAE J514



DIN 24° adaptors
DIN 2353



ORFS adaptors
ORFS J1453

Our strong points

Complete product range

We aim to make our customer's lives easier:

Only one-stop business partner for any hydraulic system.
We offer our experience and expertise during every stage, from the design to the assembly of rigid/flexible hydraulic system.

BENDED PIPES



FITTED HOSES





Applications



High performances in very extreme conditions



Certifications



MINE SAFETY AND HEALTH
ADMINISTRATION
(MSHA)



DET NORSKE VERITAS (DNV)
GERMANISCHER LLOYD (GL)



RINA (Registro Navale Italiano)

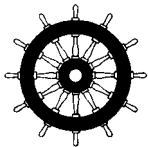

MarED



GOST-R



TEST
Opniujacej Atestujacej I Certyfikujacej
Wiroby Test Sp z.o.o.

Components DIN

DL..DS
DIN 3870
Pg.14

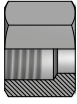

ADT LS
DOUBLE CUTTING RING
Pg. 15



CPD.LS
BULKHEAD NUT
Pg. 16



AME.LS
METRIC MALE STUD COU-
PLING Pg. 17

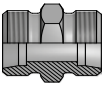

AME.LS
METRIC MALE REDUCED
COUPLING Pg. 18

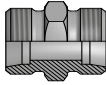

APPME.LS
BULKHEAD CONNECTION
Pg. 20

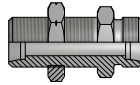

LME LS
DIN MALE EQUAL EL-
BOW-DIN MALE
Pg. 21



LPPME LS
DIN MALE BULKHEAD
ELBOW-DIN MALE
Pg. 22

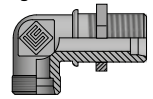

Tube to Tube

TME LS
T ADPT DIN MALE/DIN
MALE/DIN MALE
Pg. 23

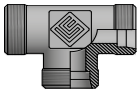

TME LS P
T ADPT DIN M/DIN M/DIN
M REDUCED
Pg. 24

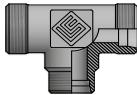

TME LS B
T ADPT DIN M/DIN M/
REDUCED DIN M
Pg. 26

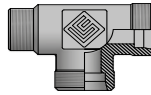

CME LS
EQUAL CROSS DIN MALE
Pg. 27

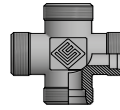

AFE.LS ME..LS
DIN FEM. STANDPIPE
RED.-DIN MALE
Pg. 28

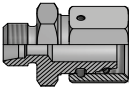

LME LS FE LS
DIN MALE STUD EL-
BOW-DIN FEM.
Pg. 33



TME LSFE LS P
T ADPT DIN M./DIN M./
DIN FEM
Pg. 34

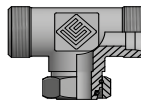

TME LSFE LS B
T ADPT DIN M./DIN FEM./
DIN M
Pg. 35

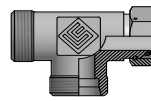

Tube to Swivel

AME. TLS
DIN MALE-DIN STANDPIPE
Pg. 36

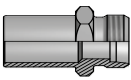

LME LS TLS
DIN M. STUD ELBOW- DIN
STANDPIPE Pg. 41

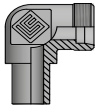

TME LTL STS B
T ADPT DIN STANDPIPE/
DIN M/DIN M Pg. 42

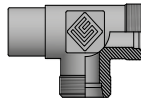

TME LTL P
T ADPT DIN M/DIN M/DIN
STANDPIPE Pg. 43

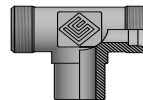

Swivel to Swivel

AFE.LS
DIN FEMALE COUPLING
-FEMALE COUPLING
Pg. 44

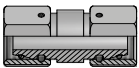

Visual index

Tube to Female

AME.LS FFG

DIN MALE STUD COUP.-
BSPP FEM.

Pg. 45

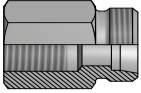

AME.LS FFM

DIN MALE STUD COUP.-
METRIC FEM.

Pg. 46

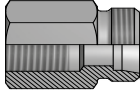

AME.LS.MG

DIN M. STUD COUPLING -
BSPP M. FORM B

Pg. 47

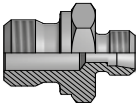

AME.LS.MG EL

DIN M. STUD COUPLING -
BSPP M. FORM E

Pg. 50

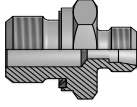

AME.LS.MG SV

DIN M. STUD COUPLING SV
60°- BSPP M.

Pg. 53

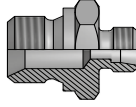

APPME.LS MG EL

DIN MALE BULKHEAD
CONN-BSPP MALE

Pg. 56

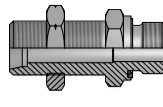

AME.LS.MM

DIN MALE STUD COUPLING
- METRIC MALE 3852
FORM B Pg. 57

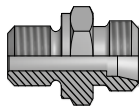

AME.LS.MM EL

DIN MALE STUD COUPLING
- METRIC MALE 3852
FORM E Pg. 59

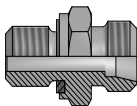

AME.LS.MU

DIN M. STUD COUPLING -
UNF/UN MALE

Pg. 61



AME.LS.MGK

DIN MALE STUD COUPLING
- BSPT MALE

Pg. 63

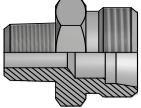

AME.LS.MN

DIN MALE STUD COUP.-
NPT MALE

Pg. 65

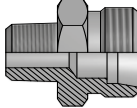

AME.LS.MMK

DIN M.STUD COUP.-M
TAPER M

Pg. 67

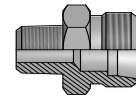

AFE.LS MG EL

DIN FEM. STUD STP ADPT-
BSPP

Pg. 68

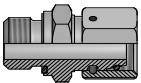

AFE.LS MM EL

DIN FEM. STUD STP
ADPT-METRIC

Pg. 69

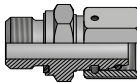

AFE.LS MN

DIN FEM. STUD STP ADPT-
NPT MALE

Pg. 70

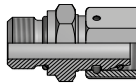

AFE.LS MU

DIN FEM. STUD STP ADPT-
UNF MALE

Pg. 71

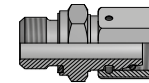

Male Stud Connector

AMG.TLS

BSPP MALE-DIN STUD
STANDPIPE

Pg. 72

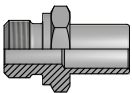

AMG.EL TLS

BSPP MALE-DIN STUD
STANDPIPE

Pg. 73

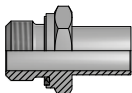

AMM.TLS

METRIC MALE-DIN STUD
STANDPIPE

Pg. 74

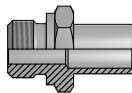

AMM.EL TLS

METRIC MALE-DIN STUD
STANDPIP

Pg. 75

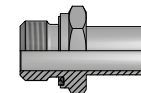

AMN.TLS

NPT MALE-DIN STUD
STANDPIPE

Pg. 76

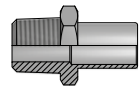

Visual index

Not Adjustable

LME LS MG

DIN MALE STUD EL-
BOW-BSPP MALE
Pg. 77

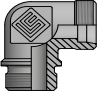

LME LS MM

DIN MALE STUD EL-
BOW-METRIC MALE
Pg. 78



LME LS MGK

DIN MALE STUD EL-
BOW-BSPT MALE
Pg. 79



LME LS MMK

DIN MALE STUD EL-
BOW-METRIC MALE
Pg. 81

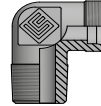

LME LS MN

DIN MALE STUD EL-
BOW-NPT MALE
Pg. 82

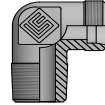

TME LS MG P

T ADPT DIN MALE/DIN
MALE/BSPP MALE
Pg. 84

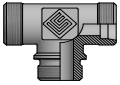

TME LS MM P

T ADPT DIN MALE/DIN
MALE/METRIC MALE
Pg. 85

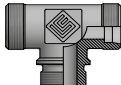

TME LS MGK P

T ADPT DIN MALE/DIN
MALE/BSPT MALE
Pg. 86



TME LS MMK P

T ADPT DIN M/DIN M./
METR.TAPER
Pg. 87



TME LS MN P

T ADPT DIN MALE/DIN
MALE/NPT MALE
Pg. 88

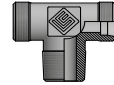

TME LS MG B

T ADPT DIN MALE/BSPP
MALE/DIN MALE
Pg. 89

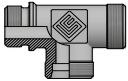

TME LS MM B

T ADPT DIN MALE/DIN
MALE/METRIC MALE
Pg. 90

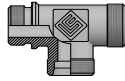

TME LS MMK B

T ADPT DIN M/DIN M./
METR.TAPER
Pg. 91

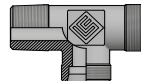

TME LS MGK B

T ADPT DIN MALE/ BSPT
MALE/DIN MALE
Pg. 92

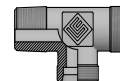

TME LS MN B

T ADPT DIN MALE/NPT
MALE/DIN MALE
Pg. 93

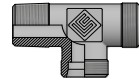

LME LS MOG

DIN MALE STUD
ELBOW-BSPP M. ADJ
Pg. 94

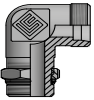

LME LS MOM

DIN M. STUD ELBOW-
METRIC M. ADJ
Pg. 95

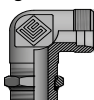

LME LS MOMR

DIN M. STUD ELBOW-
METRIC M. ADJ
Pg. 96

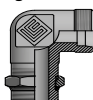

LME LS MOU

DIN MALE STUD
ELBOW-UNF M. ADJ
Pg. 97

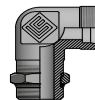

TME LS MOG P

T ADPT DIN M./DIN M./
BSPP M. ADJ
Pg. 98

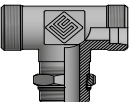

TME LS MOM P

T ADPT DIN M/DIN M/
METRIC M. ADJ
Pg. 99

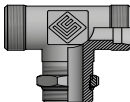

TME LS MOMR P

T ADPT DIN M/DIN M/
METRIC M. ADJ
Pg. 100

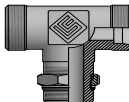

TME LS MOU P

T ADPT DIN M./DIN M./
UNF M. ADJ
Pg. 101

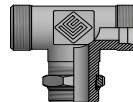

TME LS MOG B

T ADPT BSPP MALE ADJ/DIN
MALE/DIN MALE
Pg. 102



TME LS MOM B

T ADPT METRIC M ADJ/DIN
M/DIN M
Pg. 103

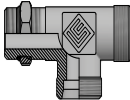

TME LS MOMR B

T ADPT METRIC M ADJ/DIN
M/DIN M
Pg. 104

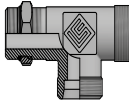

TME LS MOU B

T ADPT UNF MALE ADJ/DIN
MALE/DIN MALE
Pg. 105

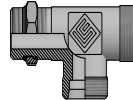

Locknut Adjustable

QME LS MOG

DIN MALE 45°ELBOW - BSPP
MALE ADJ Pg. 106



QME LS MOM

DIN M. 45°ELBOW - METRIC
M. ADJ Pg. 107

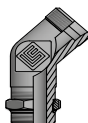

QME LS MOM R

DIN M. 45°ELBOW - METRIC
M. ADJ Pg. 108



QME LS MOU

DIN MALE 45°ELBOW - UNF
MALE ADJ Pg. 109



Banjo Fittings

LME LS BFG

DIN MALE BANJO
ELBOW - BSPP
Pg. 110

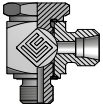

LME LS BFM

DIN MALE BANJO
ELBOW - M.
Pg. 111

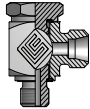

TME LS BFG P

DIN MALE BANJO TEE - BSPP
Pg. 112

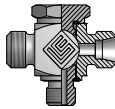

TME LS BFM P

DIN MALE BANJO TEE -
METRIC
Pg. 113

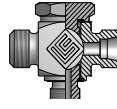

Weld Fittings

AME.LW

WELDING BOSS
Pg. 114

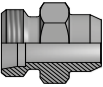

TLS. W

DIN WELDING NIPPLE
Pg. 115

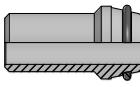

APE.LS W

WELDING BULKHEAD
CONNECTION
Pg. 116

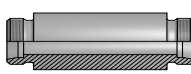

LME LS W

DIN MALE-WELDING
ELBOW Pg. 118

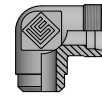

Port Reducers

ARMG ELFFG

DIN CONNECTOR BSPP
MALE-BSPP FEM
Pg. 119



APMG ELFFG

DIN CONNECTOR BSPP
MALE-BSPP FEM
Pg. 120

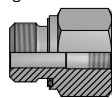

Plugs

ATFGE..LS

DIN 24° BLACKING PLUG
Pg. 121

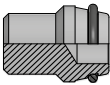

ATME..LS

DIN 24° PIPE PLUG
Pg. 122



ATMM. .ELX

DIN INNER HEXAGON PLUG
METRIC
Pg. 123



ATMG. .ELX

DIN INNER HEXAGON PLUG
BSPP
Pg. 124



NUT DIN 3870

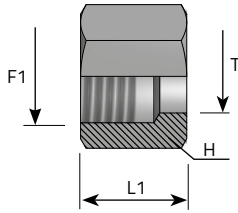

DADO DI SERRAGGIO DIN 3870
 ECROU DE SERRAGE DIN 3870
 ÜBERWURFMUTTER DIN 3870
 TUERCA DIN 3870

F1 Metrisch, Metrico, Metric, Métrique, Métrico

Code	Thread	Dimensions			Pressure		Series
		F1	T	H	L1	Bar	
		mm	mm	mm			
DL06	12X1,5	6	14	14,5	315	4568	L
DL08	14X1,5	8	17	14,5	315	4568	L
DL10	16X1,5	10	19	15,5	315	4568	L
DL12	18X1,5	12	22	15,5	315	4568	L
DL15	22X1,5	15	27	17	315	4568	L
DL18	26X1,5	18	32	18	315	4568	L
DL22	30X2	22	36	20	160	2320	L
DL28	36X2	28	41	21	160	2320	L
DL35	45X2	35	50	24	160	2320	L
DL42	52X2	42	60	24	160	2320	L
DS06	14X1,5	6	17	16,5	630	9137	S
DS08	16X1,5	8	19	16,5	630	9137	S
DS10	18X1,5	10	22	17,5	630	9137	S
DS12	20X1,5	12	24	17,5	630	9137	S
DS14	22X1,5	14	27	20,5	630	9137	S
DS16	24X1,5	16	30	20,5	400	5801	S
DS20	30X2	20	36	24	400	5801	S
DS25	36X2	25	46	27	400	5801	S
DS30	42X2	30	50	29	400	5801	S
DS38	52X2	38	60	32,5	315	4568	S

DOUBLE CUTTING RING

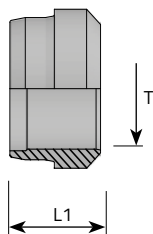

ANELLO DI SERRAGGIO A DOPPIO TAGLIENTE
BAGUE A DOUBLE COUTEAU
 DOPPELKANT-SCHNEIDRING
 ANILLO DOBLE

Code	Thread	Dimensions		Pressure		Series
		T	L1	Bar	Psi	
		mm	mm			
ADTLS06		6	9,5	315	4568	L
ADTLS08		8	9,5	315	4568	L
ADTLS10		10	10	315	4568	L
ADTLS12		12	10	315	4568	L
ADTL15		15	10	315	4568	L
ADTL18		18	10,5	315	4568	L
ADTL22		22	11	160	2320	L
ADTL28		28	11	160	2320	L
ADTL35		35	13,5	160	2320	L
ADTL42		42	13,5	160	2320	L
ADTLS06		6	9,5	630	9137	S
ADTLS08		8	9,5	630	9137	S
ADTLS10		10	10	630	9137	S
ADTLS12		12	10	630	9137	S
ADTS14		14	10	630	9137	S
ADTS16		16	10,5	400	5801	S
ADTS20		20	13	400	5801	S
ADTS25		25	13	400	5801	S
ADTS30		30	13,5	400	5801	S
ADTS38		38	13,5	315	4568	S

BULKHEAD NUT

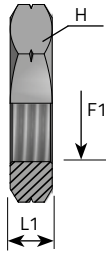

CONTRODADO PASSAPARETE DIN 80705
 CONTRE-ÉCROU
 KONTERMUTTER FÜR SCHOTT DIN 80705 – METRISCH
 TUERCA PASATABIQUE

F1 Metrisch, Metrico, Metric, Métrique, Métrico

Code	Thread	Dimensions		Pressure		Series
		H	L1	Bar	Psi	
	F1	mm	mm			L/S
CPDL6	12X1,5	17	6			L/S
CPDL8S6	14X1,5	19	6			L/S
CPDL10S8	16X1,5	22	6			L/S
CPDL12S10	18X1,5	24	6			L/S
CPDS12	20X1,5	27	6			L/S
CPDL15S14	22X1,5	30	7			L/S
CPDS16	24X1,5	32	7			L/S
CPDL18	26X1,5	36	8			L/S
CPDL22S20	30X2	41	8			L/S
CPDL28S25	36X2	46	9			L/S
CPDS30	42X2	50	9			L/S
CPDL35	45X2	55	9			L/S
CPDL42S38	52X2	65	10			L/S

METRIC- METRIC MALE STUD COUPLING

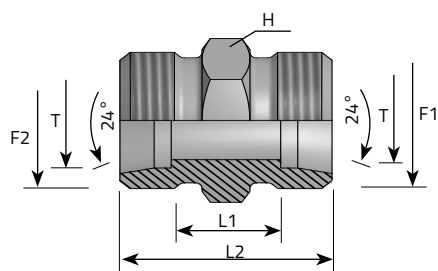

ADATTATORE DIRITTO RIDOTTO MASCHIO DIN - MASCHIO DIN
 UNION SIMPLE MÂLE
 GERADE VERSCHRAUBUNG – METRISCH 24° / METRISCH 24°
 RACOR RECTO TUBO-TUBO

F1 Metrisch, Metrico, Metric, Métrique, Métrico

F2 Metrisch, Metrico, Metric, Métrique, Métrico

Code	Thread		Dimensions				Pressure		Series
	F1	F2	T	H	L1	L2	Bar	Psi	L/S
			mm	mm	mm	mm			
AME06L.1	12x1,5	12x1,5	6	12	10	24	315	4568	L
AME08L.1	14x1,5	14x1,5	8	14	11	25	315	4568	L
AME10L.1	16x1,5	16x1,5	10	17	13	27	315	4568	L
AME12L.1	18x1,5	18x1,5	12	19	14	28	315	4568	L
AME15L.1	22x1,5	22x1,5	15	24	16	30	315	4568	L
AME18L.1	26x1,5	26x1,5	18	27	16	31	315	4568	L
AME22L.1	30x2	30x2	22	32	20	35	160	2320	L
AME28L.1	36x2	36x2	28	41	21	36	160	2320	L
AME35L.1	45x2	45x2	35	46	20	41	160	2320	L
AME42L.1	52x2	52x2	42	55	21	43	160	2320	L
AME06S.1	14x1,5	14x1,5	6	14	16	30	630	9137	S
AME08S.1	16x1,5	16x1,5	8	17	18	32	630	9137	S
AME10S.1	18x1,5	18x1,5	10	19	17	32	630	9137	S
AME12S.1	20x1,5	20x1,5	12	22	19	34	630	9137	S
AME14S.1	22x1,5	22x1,5	14	24	22	38	630	9137	S
AME16S.1	24x1,5	24x1,5	16	27	21	38	400	5801	S
AME20S.1	30x2	30x2	20	32	23	44	400	5801	S
AME25S.1	36x2	36x2	25	41	26	50	400	5801	S
AME30S.1	42x2	42x2	30	46	27	54	400	5801	S
AME38S.1	52x2	52x2	38	55	29	61	315	4568	S

DIN MALE REDUCED COUPLING - DIN MALE (1)

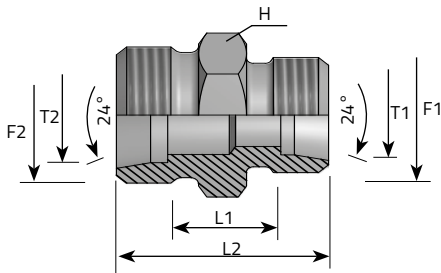

ADATTATORE DIRITTO RIDOTTO MASCHIO DIN - MASCHIO DIN
RACCORD REDUIT UNION DOUBLE
 GERADE REDUZIERVERSCHRAUBUNG – METRISCH 24° / METRISCH 24°
 RACOR UNIÓN EN REDUCCIÓN TUBO-TUBO

F1 Metrisch, Metrico, Metric, Métrique, Métrico

F2 Metrisch, Metrico, Metric, Métrique, Métrico

Code	Thread		Dimensions					Pressure		Series
	F1	F2	T1	T2	H	L1	L2	Bar	Psi	
			mm	mm	mm	mm	mm			
AME0806L.1	14x1,5	12x1,5	8	6	14	11	25	315	4568	L
AME1006L.1	16x1,5	12x1,5	10	6	17	11,5	25,5	315	4568	L
AME1008L.1	16x1,5	14x1,5	10	8	17	11,5	25,5	315	4568	L
AME1206L.1	18x1,5	12x1,5	12	6	19	12,5	26,5	315	4568	L
AME1208L.1	18x1,5	14x1,5	12	8	19	12,5	26,5	315	4568	L
AME1210L.1	18x1,5	16x1,5	12	10	19	13,5	27,5	315	4568	L
AME1510L.1	22x1,5	16x1,5	15	10	24	14,5	28,5	315	4568	L
AME1512L.1	22x1,5	18x1,5	15	12	24	14,5	28,5	315	4568	L
AME1810L.1	26x1,5	16x1,5	18	10	27	15	29,5	315	4568	L
AME1812L.1	26x1,5	18x1,5	18	12	27	15	29,5	315	4568	L
AME1815L.1	26x1,5	22x1,5	18	15	27	16,5	31	315	4568	L
AME2212L.1	30x2	18x1,5	22	12	32	17	31,5	160	2320	L
AME2215L.1	30x2	22x1,5	22	15	32	18,5	33	160	2320	L
AME2218L.1	30x2	26x1,5	22	18	32	18	33	160	2320	L
AME2818L.1	36x2	26x1,5	28	18	41	19	34	160	2320	L
AME2822L.1	36x2	30x2	28	22	41	21	36	160	2320	L
AME3522L.1	45x2	30x2	35	22	46	21	39	160	2320	L
AME3528L.1	45x2	36x2	35	28	46	21	39	160	2320	L
AME0806S.1	16x1,5	14x1,5	8	6	17	18	32	630	9137	S
AME1006S.1	18x1,5	14x1,5	10	6	19	17,5	32	630	9137	S

DIN MALE REDUCED COUPLING - DIN MALE (2)

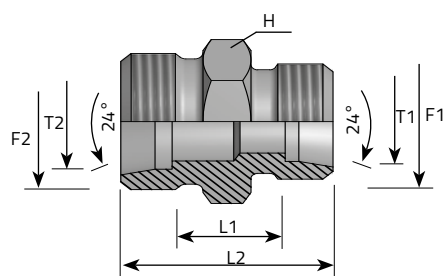

ADATTATORE DIRITTO RIDOTTO MASCHIO DIN - MASCHIO DIN
RACCORD REDUIT UNION DOUBLE
 GERADE REDUZIERVERSCHRAUBUNG – METRISCH 24° / METRISCH 24°
 RACOR UNIÓN EN REDUCCIÓN TUBO-TUBO

F1 Metrisch, Metrico, Metric, Métrique, Métrico

F2 Metrisch, Metrico, Metric, Métrique, Métrico

Code	Thread		Dimensions					Pressure		Series
	F1	F2	T1	T2	H	L1	L2	Bar	Psi	
			mm	mm	mm	mm	mm			
AME1008S.1	18x1,5	16x1,5	10	8	19	17,5	32	630	9137	S
AME1206S.1	20x1,5	14x1,5	12	6	22	18,5	33	630	9137	S
AME1208S.1	20x1,5	16x1,5	12	8	22	18,5	33	630	9137	S
AME1210S.1	20x1,5	18x1,5	12	10	22	18	33	630	9137	S
AME1410S.1	22x1,5	18x1,5	14	10	24	20,5	36	630	9137	S
AME1412S.1	22x1,5	20x1,5	14	12	24	20,5	36	630	9137	S
AME1612S.1	24x1,5	20x1,5	16	12	27	21	37	400	5801	S
AME1614S.1	24x1,5	22x1,5	16	14	27	22,5	39	400	5801	S
AME2010S.1	30x2	18x1,5	20	10	32	23	41	400	5801	S
AME2012S.1	30x2	20x1,5	20	12	32	23	41	400	5801	S
AME2014S.1	30x2	22x1,5	20	14	32	24	42,5	400	5801	S
AME2016S.1	30x2	24x1,5	20	16	32	24	43	400	5801	S
AME2516S.1	36x2	24x1,5	25	16	41	27,5	48	400	5801	S
AME2520S.1	36x2	30x2	25	20	41	25,5	48	400	5801	S
AME3020S.1	42x2	30x2	30	20	46	28	52	400	5801	S
AME3025S.1	42x2	36x2	30	25	46	28,5	54	400	5801	S
AME3825S.1	52x2	36x2	38	25	55	30	58	315	4568	S
AME3830S.1	52x2	42x2	38	30	55	30,5	60	315	4568	S

DIN MALE BULKHEAD CONNECTION-DIN MALE

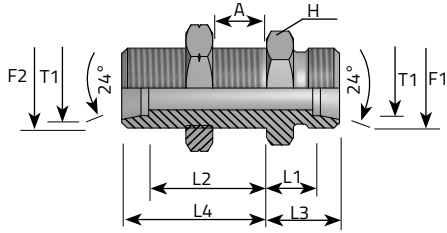

PASSAPARETE DIRITTO MASCHIO DIN - MASCHIO DIN
 UNION DOUBLE. TRAVERSÉE DE CLOISON
 GERADE SCHOTTVERSCHRAUBUNG - METRISCH 24° / METRISCH 24°
 RACOR RECTO PASATABIQUE TUBO-TUBO

F1 Metrisch, Metrico, Metric, Métrique, Métrico

F2 Metrisch, Metrico, Metric, Métrique, Métrico

Code	Thread		Dimensions							Pressure		Series
	F1	F2	T1	H	A	L1	L2	L3	L4	Bar	Psi	
			mm	mm	mm	mm	mm	mm	mm			
APPME06L.1	12x1,5	12x1,5	6	17	16	7	27	14	34	315	4568	L
APPME08L.1	14x1,5	14x1,5	8	19	16	8	27	15	34	315	4568	L
APPME10L.1	16x1,5	16x1,5	10	22	16	10	28	17	35	315	4568	L
APPME12L.1	18x1,5	18x1,5	12	24	16	10	29	17	36	315	4568	L
APPME15L.1	22x1,5	22x1,5	15	27	16	12	31	19	38	315	4568	L
APPME18L.1	26x1,5	26x1,5	18	32	16	13,5	32,5	21	40	315	4568	L
APPME22L.1	30x2	30x2	22	36	16	16,5	34,5	24	42	160	2320	L
APPME28L.1	36x2	36x2	28	41	16	18,5	35,5	26	43	160	2320	L
APPME35L.1	45x2	45x2	35	50	16	18,5	36,5	29	47	160	2320	L
APPME42L.1	52x2	52x2	42	60	16	19	36	30	47	160	2320	L
APPME06S.1	14x1,5	14x1,5	6	19	16	12	29	19	36	630	9137	S
APPME08S.1	16x1,5	16x1,5	8	22	16	13	29	20	36	630	9137	S
APPME10S.1	18x1,5	18x1,5	10	24	16	14,5	29,5	22	37	630	9137	S
APPME12S.1	20x1,5	20x1,5	12	27	16	14,5	30,5	22	38	630	9137	S
APPME14S.1	22x1,5	22x1,5	14	30	16	17	32	25	40	630	9137	S
APPME16S.1	24x1,5	24x1,5	16	32	16	16,5	31,5	25	40	400	5801	S
APPME20S.1	30x2	30x2	20	41	16	17,5	33,5	28	44	400	5801	S
APPME25S.1	36x2	36x2	25	46	16	20	35	32	47	400	5801	S
APPME30S.1	42x2	42x2	30	50	16	21,5	37,5	35	51	400	5801	S
APPME38S.1	52x2	52x2	38	65	16	22	37	38	53	315	4568	S

DIN MALE EQUAL ELBOW-DIN MALE

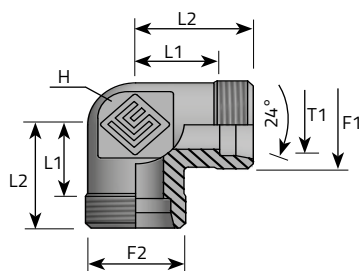

GOMITO PASSAPARETE MASCHIO DIN - MASCHIO DIN
 COUDE ÉGAL DIN/DIN
 WINKEL-VERSCHRAUBUNG 90° - 24° METRISCH / 24° METRISCH
 RACOR UNION CODO DIN/DIN

F1 Metrisch, Metrico, Metric, Métrique, Métrico

F2 Metrisch, Metrico, Metric, Métrique, Métrico

Code	Thread		Dimensions				Pressure		Series
	F1	F2	T1	H	L1	L2	Bar	Psi	
			mm	mm	mm	mm	L/S		
LME06L.1	12X1,5	12X1,5	6	12	12	19	315	4568	L
LME08L.1	14X1,5	14X1,5	8	12	14	21	315	4568	L
LME10L.1	16X1,5	16X1,5	10	14	15	22	315	4568	L
LME12L.1	18X1,5	18X1,5	12	17	17	24	315	4568	L
LME15L.1	22X1,5	22X1,5	15	19	21	28	315	4568	L
LME18L.1	26X1,5	26X1,5	18	24	23,5	31	315	4568	L
LME22L.1	30X2	30X2	22	27	27,5	35	160	2320	L
LME28L.1	36X2	36X2	28	36	30,5	38	160	2320	L
LME35L.1	45X2	45X2	35	41	34,5	45	160	2320	L
LME42L.1	52X2	52X2	42	50	40	51	160	2320	L
LME06S.1	14X1,5	14X1,5	6	12	16	23	630	9137	S
LME08S.1	16X1,5	16X1,5	8	14	17	24	630	9137	S
LME10S.1	18X1,5	18X1,5	10	17	17,5	25	630	9137	S
LME12S.1	20X1,5	20X1,5	12	17	21,5	29	630	9137	S
LME14S.1	22X1,5	22X1,5	14	19	22	30	630	9137	S
LME16S.1	24X1,5	24X1,5	16	24	24,5	33	400	5801	S
LME20S.1	30X2	30X2	20	27	26,5	37	400	5801	S
LME25S.1	36X2	36X2	25	36	30	42	400	5801	S
LME30S.1	42X2	42X2	30	41	35,5	49	400	5801	S
LME38S.1	52X2	52X2	38	50	41	57	315	4568	S

DIN MALE BULKHEAD ELBOW-DIN MALE

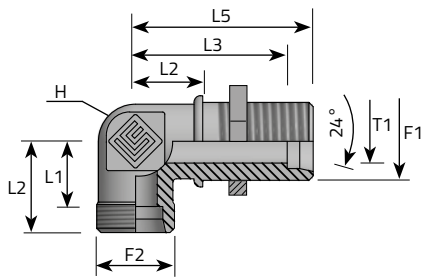

GOMITO PASSAPARETE MASCHIO DIN - MASCHIO DIN
 COUDE ÉGAL - TRAVERSÉE DE CLOISON
 WINKEL-SCHOTTVERSCHRAUBUNG 90° - 24° METRISCH / 24°
 METRISCH
 RACOR EN CODO PASATABIQUE TUBO-TUBO

F1 Metrisch, Metrico, Metric, Métrique, Métrico

F2 Metrisch, Metrico, Metric, Métrique, Métrico

Code	Thread		Dimensions							Pressure		Series
	F1	F2	T1	H	L1	L2	L3	L4	L5	Bar	Psi	
LPPME06L.1	12X1,5	12X1,5	6	12	12	14	27	19	34	315	4568	L
LPPME08L.1	14X1,5	14X1,5	8	12	14	17	27	21	34	315	4568	L
LPPME10L.1	16X1,5	16X1,5	10	14	15	18	28	22	35	315	4568	L
LPPME12L.1	18X1,5	18X1,5	12	17	17	20	29	24	36	315	4568	L
LPPME15L.1	22X1,5	22X1,5	15	19	21	23	31	28	38	315	4568	L
LPPME18L.1	26X1,5	26X1,5	18	24	23,5	24	32,5	31	40	315	4568	L
LPPME22L.1	30X2	30X2	22	27	27,5	30	34,5	35	42	160	2320	L
LPPME28L.1	36X2	36X2	28	36	30,5	34	35,5	38	43	160	2320	L
LPPME35L.1	45X2	45X2	35	41	34,5	39	36,5	45	47	160	2320	L
LPPME42L.1	52X2	52X2	42	50	40	43	36	51	47	160	2320	L
LPPME06S.1	14X1,5	14X1,5	6	12	16	17	29	23	36	630	9137	S
LPPME08S.1	16X1,5	16X1,5	8	14	17	18	29	24	36	630	9137	S
LPPME10S.1	18X1,5	18X1,5	10	17	17,5	20	29,5	25	37	630	9137	S
LPPME12S.1	20X1,5	20X1,5	12	17	21,5	21	30,5	29	38	630	9137	S
LPPME14S.1	22X1,5	22X1,5	14	19	22	23	32	30	40	630	9137	S
LPPME16S.1	24X1,5	24X1,5	16	24	24,5	24	31,5	33	40	400	5801	S
LPPME20S.1	30X2	30X2	20	27	26,5	30	33,5	37	44	400	5801	S
LPPME25S.1	36X2	36X2	25	36	30	34	35	42	47	400	5801	S
LPPME30S.1	42X2	42X2	30	41	35,5	39	37,5	49	51	400	5801	S
LPPME38S.1	52X2	52X2	38	50	41	43	37	57	53	315	4568	S

T ADAPTER DIN MALE/DIN MALE/DIN MALE

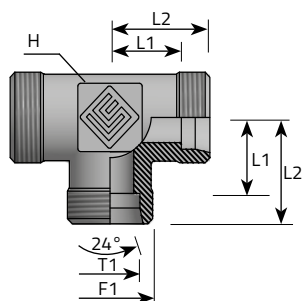

ADATTATORE T MASCHIO DIN
TÉ ÉGAL
T-VERSCHRAUBUNG – 3 X DIN 24° METRISCH
RACOR UNION EN T TUBO – TUBO

F1 Metrisch, Metrico, Metric, Métrique, Métrico

F2 Metrisch, Metrico, Metric, Métrique, Métrico

Code	Thread		Dimensions						Pressure		Series
	F1	F2	T1	H	L1	L2	L3	L4	Bar	Psi	
TME06L.1	12X1,5	12X1,5	6	12	12	19			315	4568	L
TME08L.1	14X1,5	14X1,5	8	12	14	21			315	4568	L
TME10L.1	16X1,5	16X1,5	10	14	15	22			315	4568	L
TME12L.1	18X1,5	18X1,5	12	17	17	24			315	4568	L
TME15L.1	22X1,5	22X1,5	15	19	21	28			315	4568	L
TME18L.1	26X1,5	26X1,5	18	24	23,5	31			315	4568	L
TME22L.1	30X2	30X2	22	27	27,5	35			160	2320	L
TME28L.1	36X2	36X2	28	36	30,5	38			160	2320	L
TME35L.1	45X2	45X2	35	41	34,5	45			160	2320	L
TME42L.1	52X2	52X2	42	50	40	51			160	2320	L
TME06S.1	14X1,5	14X1,5	6	12	16	23			630	9137	S
TME08S.1	16X1,5	16X1,5	8	14	17	24			630	9137	S
TME10S.1	18X1,5	18X1,5	10	17	17,5	25			630	9137	S
TME12S.1	20X1,5	20X1,5	12	17	21,5	29			630	9137	S
TME14S.1	22X1,5	22X1,5	14	19	22	30			630	9137	S
TME16S.1	24X1,5	24X1,5	16	24	24,5	33			400	5801	S
TME20S.1	30X2	30X2	20	27	26,5	37			400	5801	S
TME25S.1	36X2	36X2	25	36	30	42			400	5801	S
TME30S.1	42X2	42X2	30	41	35,5	49			400	5801	S
TME38S.1	52X2	52X2	38	50	41	57			315	4568	S

T ADPT DIN MALE/DIN MALE/DIN MALE REDUCED (1)

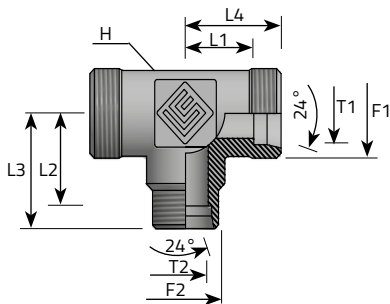

ADATTATORE T MASCHIO DIN RIDOTTO AL PIEDE
TÉ REDUCTION
 T-VERSCHRAUBUNG – 3 X DIN 24° METRISCH
 REDUCCIONES UNION EN T TUBO – TUBO

F1 Metrisch, Metrico, Metric, Métrique, Métrico

F2 Metrisch, Metrico, Metric, Métrique, Métrico

Code	Thread		Dimensions							Pressure		Series
	F1	F2	T1	T2	H	L1	L2	L3	L4	Bar	Psi	
TME0608LP.1	12X1,5	14X1,5	6	8	12	12	12	19	19	315	4568	L
TME0806LP.1	14X1,5	12X1,5	8	6	12	12	12	19	19	315	4568	L
TME0610LP.1	12X1,5	16X1,5	6	10	14	15	15	22	22	315	4568	L
TME0810LP.1	14X1,5	16X1,5	8	10	14	15	15	22	22	315	4568	L
TME1006LP.1	16X1,5	12X1,5	10	6	14	15	15	22	22	315	4568	L
TME1008LP.1	16X1,5	14X1,5	10	8	14	15	15	22	22	315	4568	L
TME0812LP.1	14X1,5	18X1,5	8	12	17	17	17	24	24	315	4568	L
TME1206LP.1	18X1,5	12X1,5	12	6	17	17	17	24	24	315	4568	L
TME1208LP.1	18X1,5	14X1,5	12	8	17	17	17	24	24	315	4568	L
TME1210LP.1	18X1,5	16X1,5	12	10	17	17	17	24	24	315	4568	L
TME1015LP.1	16X1,5	22X1,5	10	15	19	21	21	28	28	315	4568	L
TME1215LP.1	18X1,5	22X1,5	12	15	19	21	21	28	28	315	4568	L
TME1506LP.1	22X1,5	12X1,5	15	6	19	21	21	28	28	315	4568	L
TME1510LP.1	22X1,5	16X1,5	15	10	19	21	21	28	28	315	4568	L
TME1512LP.1	22X1,5	18X1,5	15	12	19	21	21	28	28	315	4568	L
TME1218LP.1	18X1,5	26X1,5	12	18	24	23,5	23,5	30,5	30,5	315	4568	L
TME1810LP.1	26X1,5	16X1,5	18	10	24	23,5	23,5	30,5	30,5	315	4568	L
TME1812LP.1	26X1,5	18X1,5	18	12	24	23,5	23,5	31	30,5	315	4568	L
TME1815LP.1	26X1,5	22X1,5	18	15	24	23,5	23,5	31	30,5	315	4568	L
TME2210LP.1	30X2	16X1,5	22	10	27	27,5	27,5	35	34,5	160	2320	L
TME2212LP.1	30X2	18X1,5	22	12	27	27,5	27,5	35	34,5	160	2320	L
TME2215LP.1	30X2	22X1,5	22	15	27	27,5	27,5	35	34,5	160	2320	L
TME2218LP.1	30X2	26X1,5	22	18	27	27,5	27,5	35	35	160	2320	L

T ADPT DIN MALE/DIN MALE/DIN MALE REDUCED (2)

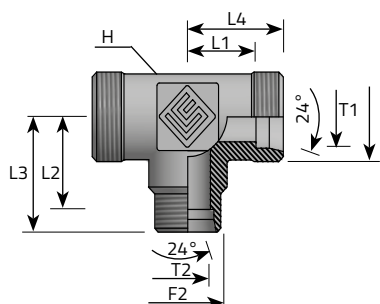

ADATTATORE T MASCHIO DIN RIDOTTO AL PIEDE
TÉ REDUCTION
 T-VERSCHRAUBUNG – 3 X DIN 24° METRISCH
REDUCCIONES UNION EN T TUBO – TUBO

F1 Metrisch, Metrico, Metric, Métrique, Métrico

F2 Metrisch, Metrico, Metric, Métrique, Métrico

Code	Thread		Dimensions							Pressure		Series
	F1	F2	T1	T2	H	L1	L2	L3	L4	Bar	Psi	
TME2810LP.1	36X2	16X1,5	28	10	36	30,5	30,5	38	37,5	160	2320	L
TME2812LP.1	36X2	18X1,5	28	12	36	30,5	30,5	38	37,5	160	2320	L
TME2815LP.1	36X2	22X1,5	28	15	36	30,5	30,5	38	37,5	160	2320	L
TME2818LP.1	36X2	26X1,5	28	18	36	30,5	30,5	38	38	160	2320	L
TME2822LP.1	36X2	30X2	28	22	36	30,5	30,5	38	38	160	2320	L
TME1006SP.1	18X1,5	14X1,5	10	6	17	17,5	17,5	25	24,5	630	9137	S
TME1208SP.1	20X1,5	16X1,5	12	8	17	21,5	21,5	29	28,5	630	9137	S
TME1210SP.1	20X1,5	18X1,5	12	10	17	21,5	21,5	29	29	630	9137	S
TME1216SP.1	20X1,5	24X1,5	12	16	24	24,5	24,5	32	33	400	5801	S
TME1606SP.1	24X1,5	14X1,5	16	6	24	24,5	24,5	33	31,5	400	5801	S
TME1608SP.1	24X1,5	16X1,5	16	8	24	24,5	24,5	33	31,5	400	5801	S
TME1610SP.1	24X1,5	18X1,5	16	10	24	24,5	24,5	33	32	400	5801	S
TME1612SP.1	24X1,5	20X1,5	16	12	24	24,5	24,5	33	32	400	5801	S
TME1620SP.1	24X1,5	30X2	16	20	27	26,5	26,5	35	37	400	5801	S
TME2010SP.1	30X2	18X1,5	20	10	27	26,5	26,5	35	37	400	5801	S
TME2012SP.1	30X2	20X1,5	20	12	27	26,5	26,5	37	34	400	5801	S
TME2016SP.1	30X2	24X1,5	20	16	27	26,5	26,5	37	35	400	5801	S
TME2025SP.1	30X2	36X2	20	25	36	30	30	40,5	42	400	5801	S
TME2516SP.1	36X2	24X1,5	25	16	36	30	30	42	38,5	400	5801	S
TME2520SP.1	36X2	30X2	25	20	36	30	30	42	40,5	400	5801	S
TME2530SP.1	36X2	42X2	25	30	41	35,5	35,5	47,5	49	400	5801	S

T ADAPTER DIN MALE REDUCED/DIN MALE/DIN MALE

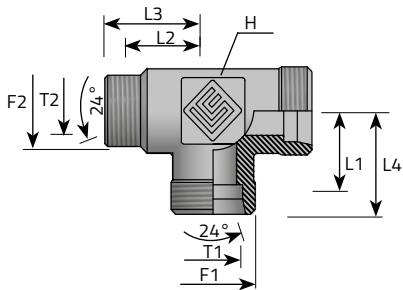

ADATTATORE T MASCHIO DIN RIDOTTO AL BRACCIO
 TÉ REDUCTION
 T-VERSCHRAUBUNG – 3 X DIN 24° METRISCH
 REDUCCIONES UNION EN T TUBO – TUBO

F1 Metrisch, Metrico, Metric, Métrique, Métrico

F2 Metrisch, Metrico, Metric, Métrique, Métrico

Code	Thread		Dimensions							Pressure		Series
	F1	F2	T1	T2	H	L1	L2	L3	L4	Bar	Psi	
TME0812LB.1	14X1,5	18X1,5	8	12	17	17	17	24	24	315	4568	L
TME1006LB.1	16X1,5	12X1,5	10	6	14	15	15	22	22	315	4568	L
TME1018LB.1	16X1,5	26X1,5	10	18	24	23,5	23,5	30,5	31	315	4568	L
TME1210LB.1	18X1,5	16X1,5	12	10	17	17	17	24	24	315	4568	L
TME1215LB.1	18X1,5	22X1,5	12	15	19	21	21	28	28	315	4568	L
TME1512LB.1	22X1,5	18X1,5	15	12	19	21	21	28	28	315	4568	L
TME1522LB.1	22X1,5	30X2	15	22	27	27,5	27,5	34,5	35	315	4568	L
TME1810LB.1	26X1,5	16X1,5	18	10	24	23,5	23,5	31	31,5	315	4568	L
TME1822LB.1	26X1,5	30X2	18	22	27	27,5	27,5	35	35	160	2320	L
TME2218LB.1	30X2	26X1,5	22	18	27	27,5	27,5	35	35	160	2320	L
TME2228LB.1	30X2	36X2	22	28	36	30,5	30,5	38	38	160	2320	L
TME0812SB.1	16X1,5	20X1,5	8	12	17	21,5	21,5	28,5	28,5	630	9137	S

EQUAL CROSS DIN MALE

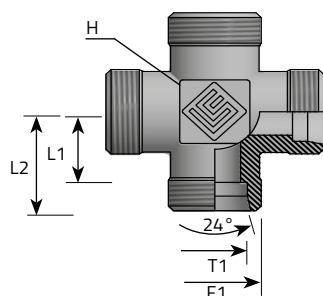

ADATTATORE A CROCE MASCHIO DIN
CROIX ÉGALE
 KREUZ-VERSCHRAUBUNG – 4 X DIN 24° METRISCH
 RACOR UNION EN CRUZ TUBO – TUBO

F1 Metrisch, Metrico, Metric, Métrique, Métrico

Code	Thread	Dimensions				Pressure		Series
		F1	T1	H	L1	L2	Bar	
		mm	mm	mm	mm			
CME06L.1	12X1,5	6	12	12	19	315	4568	L
CME08L.1	14X1,5	8	12	14	21	315	4568	L
CME10L.1	16X1,5	10	14	15	22	315	4568	L
CME12L.1	18X1,5	12	17	17	24	315	4568	L
CME15L.1	22X1,5	15	19	21	28	315	4568	L
CME18L.1	26X1,5	18	24	23,5	31	315	4568	L
CME22L.1	30X2	22	27	27,5	35	160	2320	L
CME28L.1	36X2	28	36	30,5	38	160	2320	L
CME35L.1	45X2	35	41	34,5	45	160	2320	L
CME42L.1	52X2	42	50	40	51	160	2320	L
CME06S.1	14X1,5	6	12	16	23	630	9137	S
CME08S.1	16X1,5	8	14	17	24	630	9137	S
CME10S.1	18X1,5	10	17	17,5	25	630	9137	S
CME12S.1	20X1,5	12	17	21,5	29	630	9137	S
CME14S.1	22X1,5	14	19	22	30	630	9137	S
CME16S.1	24X1,5	16	24	24,5	33	400	5801	S
CME20S.1	30X2	20	27	26,5	37	400	5801	S
CME25S.1	36X2	25	36	30	42	400	5801	S
CME30S.1	42X2	30	41	35,5	49	400	5801	S
CME38S.1	52X2	38	50	41	57	315	4568	S

DIN FEMALE STANDPIPE REDUCER WITH O-RING-DIN MALE (1)

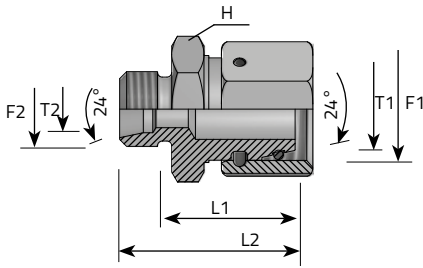

RIDUZIONE FEMMINA GIREVOLE DIN CON O-RING-MASCHIO DIN
 ADAPTEUR DE RÉDUCTION AVEC O-RING
 REDUZIEREINSATZ MIT O-RING ABDICHTUNG – DKOL 24° / MET. 24°
 RACOR DE REDUCCIÓN CON JUNTA TÓRICA

F1 Metrisch, Metrico, Metric, Métrique, Métrico

F2 Metrisch, Metrico, Metric, Métrique, Métrico

Code	Thread		Dimensions					Pressure		Series	
	F1	F2	T1	T2	H	L1	L2	Bar	Psi		L/S
			mm	mm	mm	mm	mm				
AFE08LME06L.1	14X1,5	12X1,5	8	6	12	23.5	30.5	315	4568	L	
AFE10LME06L.1	16X1,5	12X1,5	10	6	14	25	32	315	4568	L	
AFE10LME08L.1	16X1,5	14X1,5	10	8	14	25	32	315	4568	L	
AFE12LME06L.1	18X1,5	12X1,5	12	6	17	25	32	315	4568	L	
AFE12LME08L.1	18X1,5	14X1,5	12	8	17	25	32	315	4568	L	
AFE12LME10L.1	18X1,5	16X1,5	12	10	17	26	33	315	4568	L	
AFE15LME06L.1	22X1,5	12X1,5	15	6	19	28.5	35.5	315	4568	L	
AFE15LME08L.1	22X1,5	14X1,5	15	8	19	28.5	35.5	315	4568	L	
AFE15LME10L.1	22X1,5	16X1,5	15	10	19	29.5	36.5	315	4568	L	
AFE15LME12L.1	22X1,5	18X1,5	15	12	19	29.5	36.5	315	4568	L	
AFE18LME06L.1	26X1,5	12X1,5	18	6	24	28	35	315	4568	L	
AFE18LME08L.1	26X1,5	14X1,5	18	8	24	28	35	315	4568	L	
AFE18LME10L.1	26X1,5	16X1,5	18	10	24	29	36	315	4568	L	
AFE18LME12L.1	26X1,5	18X1,5	18	12	24	29	36	315	4568	L	
AFE18LME15L.1	26X1,5	22X1,5	18	15	24	30	37	315	4568	L	
AFE22LME06L.1	30X2	12X1,5	22	6	27	32	39	160	2320	L	
AFE22LME08L.1	30X2	14X1,5	22	8	27	32	39	160	2320	L	
AFE22LME10L.1	30X2	16X1,5	22	10	27	33	40	160	2320	L	
AFE22LME12L.1	30X2	18X1,5	22	12	27	33	40	160	2320	L	
AFE22LME15L.1	30X2	22X1,5	22	15	27	34	41	160	2320	L	
AFE22LME18L.1	30X2	26X1,5	22	18	27	33.5	41	160	2320	L	

DIN FEMALE STANDPIPE REDUCER WITH O-RING-DIN MALE (2)

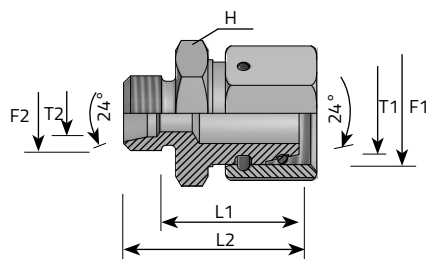

RIDUZIONE FEMMINA GIREVOLE DIN CON O-RING—MASCHIO DIN
 ADAPTEUR DE RÉDUCTION AVEC O-RING
 REDUZIEREINSATZ MIT O-RING ABDICHTUNG – DKOL 24° / MET. 24°
 RACOR DE REDUCCIÓN CON JUNTA TÓRICA

F1 Metrisch, Metrico, Metric, Métrique, Métrico

F2 Metrisch, Metrico, Metric, Métrique, Métrico

Code	Thread		Dimensions					Pressure		Series
	F1	F2	T1	T2	H	L1	L2	Bar	Psi	
			mm							L/S
AFE28LME06L.1	36X2	12X1,5	28	6	32	34	41	160	2320	L
AFE28LME08L.1	36X2	14X1,5	28	8	32	34	41	160	2320	L
AFE28LME10L.1	36X2	16X1,5	28	10	32	35	42	160	2320	L
AFE28LME12L.1	36X2	18X1,5	28	12	32	35	42	160	2320	L
AFE28LME15L.1	36X2	22X1,5	28	15	32	36	43	160	2320	L
AFE28LME18L.1	36X2	26X1,5	28	18	32	36.5	44	160	2320	L
AFE28LME22L.1	36X2	30X2	28	22	32	37.5	45	160	2320	L
AFE35LME06L.1	45X2	12X1,5	35	6	41	37	44	160	2320	L
AFE35LME08L.1	45X2	14X1,5	35	8	41	37	44	160	2320	L
AFE35LME10L.1	45X2	16X1,5	35	10	41	38	45	160	2320	L
AFE35LME12L.1	45X2	18X1,5	35	12	41	38	45	160	2320	L
AFE35LME15L.1	45X2	22X1,5	35	15	41	39	46	160	2320	L
AFE35LME18L.1	45X2	26X1,5	35	18	41	38.5	46	160	2320	L
AFE35LME22L.1	45X2	30X2	35	22	41	40.5	48	160	2320	L
AFE35LME28L.1	45X2	36X2	35	28	41	40.5	48	160	2320	L
AFE42LME06L.1	52X2	12X1,5	42	6	50	40.5	47.5	160	2320	L
AFE42LME08L.1	52X2	14X1,5	42	8	50	40.5	47.5	160	2320	L
AFE42LME10L.1	52X2	16X1,5	42	10	50	41.5	48.5	160	2320	L
AFE42LME12L.1	52X2	18X1,5	42	12	50	41.5	48.5	160	2320	L
AFE42LME15L.1	52X2	22X1,5	42	15	50	42.5	49.5	160	2320	L
AFE42LME18L.1	52X2	26X1,5	42	18	50	42	49.5	160	2320	L
AFE42LME22L.1	52X2	30X2	42	22	50	44	51.5	160	2320	L

DIN FEMALE STANDPIPE REDUCER WITH O-RING-DIN MALE (3)

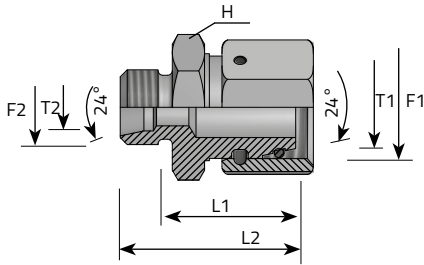

RIDUZIONE FEMMINA GIREVOLE DIN CON O-RING-MASCHIO DIN
 ADAPTEUR DE RÉDUCTION AVEC O-RING
 REDUZIEREINSATZ MIT O-RING ABDICHTUNG – DKOL 24° / MET. 24°
 RACOR DE REDUCCIÓN CON JUNTA TÓRICA

F1 Metrisch, Metrico, Metric, Métrique, Métrico

F2 Metrisch, Metrico, Metric, Métrique, Métrico

Code	Thread		Dimensions					Pressure		Series
	F1	F2	T1	T2	H	L1	L2	Bar	Psi	
			mm							
AFE42LME28L.1	52X2	36X2	42	28	50	44	51.5	160	2320	L
AFE42LME35L.1	52X2	42X2	42	35	50	43	53.5	160	2320	L
AFE08SME06S.1	16X1,5	14X1,5	8	6	14	27	34	630	9137	S
AFE10SME06S.1	18X1,5	14X1,5	10	6	17	27.5	34.5	630	9137	S
AFE10SME08S.1	18X1,5	16X1,5	10	8	17	27.5	34.5	630	9137	S
AFE12SME06S.1	20X1,5	14X1,5	12	6	17	29	36	630	9137	S
AFE12SME08S.1	20X1,5	16X1,5	12	8	17	29	36	630	9137	S
AFE12SME10S.1	20X1,5	18X1,5	12	10	19	29.5	37	630	9137	S
AFE14SME06S.1	22X1,5	14X1,5	14	6	19	31.5	38.5	630	9137	S
AFE14SME08S.1	22X1,5	16X1,5	14	8	19	31.5	38.5	630	9137	S
AFE14SME10S.1	22X1,5	18X1,5	14	10	19	31	38.5	630	9137	S
AFE14SME12S.1	22X1,5	20X1,5	14	12	22	31	38.5	630	9137	S
AFE16SME06S.1	24X1,5	14X1,5	16	6	22	32	39	400	5801	S
AFE16SME08S.1	24X1,5	16X1,5	16	8	22	32	39	400	5801	S
AFE16SME10S.1	24X1,5	18X1,5	16	10	22	31.5	38.5	400	5801	S
AFE16SME12S.1	24X1,5	20X1,5	16	12	22	31.5	39	400	5801	S
AFE16SME14S.1	24X1,5	22X1,5	16	14	24	33	41	400	5801	S
AFE20SME06S.1	30X2	14X1,5	20	6	27	36	43	400	5801	S
AFE20SME08S.1	30X2	16X1,5	20	8	27	35.5	42.5	400	5801	S
AFE20SME10S.1	30X2	18X1,5	20	10	27	35.5	43	400	5801	S
AFE20SME12S.1	30X2	20X1,5	20	12	27	37	44.5	400	5801	S
AFE20SME14S.1	30X2	22X1,5	20	14	27	36.5	44.5	400	5801	S

DIN FEMALE STANDPIPE REDUCER WITH O-RING-DIN MALE (4)

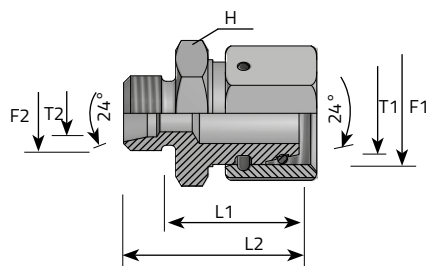

RIDUZIONE FEMMINA GIREVOLE DIN CON O-RING—MASCHIO DIN
 ADAPTEUR DE RÉDUCTION AVEC O-RING
 REDUZIEREINSATZ MIT O-RING ABDICHTUNG – DKOL 24° / MET. 24°
 RACOR DE REDUCCIÓN CON JUNTA TÓRICA

F1 Metrisch, Metrico, Metric, Métrique, Métrico

F2 Metrisch, Metrico, Metric, Métrique, Métrico

Code	Thread		Dimensions					Pressure		Series
	F1	F2	T1	T2	H	L1	L2	Bar	Psi	
			mm							
AFE20SME16S.1	30X2	24X1,5	20	16	27	38.5	47	400	5801	S
AFE25SME06S.1	36X2	14X1,5	25	6	32	38.5	45.5	400	5801	S
AFE25SME08S.1	36X2	16X1,5	25	8	32	38	45	400	5801	S
AFE25SME10S.1	36X2	18X1,5	25	10	32	38	45.5	400	5801	S
AFE25SME12S.1	36X2	20X1,5	25	12	32	38	45.5	400	5801	S
AFE25SME14S.1	36X2	22X1,5	25	14	32	39.5	47.5	400	5801	S
AFE25SME16S.1	36X2	24X1,5	25	16	32	39	47.5	400	5801	S
AFE25SME20S.1	36X2	30X2	25	20	32	39	49.5	400	5801	S
AFE30SME06S.1	42X2	14X1,5	30	6	41	44	51	400	5801	S
AFE30SME08S.1	42X2	16X1,5	30	8	41	44	51	400	5801	S
AFE30SME10S.1	42X2	18X1,5	30	10	41	43.5	51	400	5801	S
AFE30SME12S.1	42X2	20X1,5	30	12	41	43.5	51	400	5801	S
AFE30SME14S.1	42X2	22X1,5	30	14	41	45	53	400	5801	S
AFE30SME16S.1	42X2	24X1,5	30	16	41	44.5	53	400	5801	S
AFE30SME20S.1	42X2	30X2	30	20	41	44.5	55	400	5801	S
AFE30SME25S.1	42X2	36X2	30	25	41	45	57	400	5801	S
AFE38SME06S.1	52X2	14X1,5	38	6	50	47.5	54.5	315	4568	S
AFE38SME08S.1	52X2	16X1,5	38	8	50	47.5	54.5	315	4568	S
AFE38SME10S.1	52X2	18X1,5	38	10	50	47	54	315	4568	S
AFE38SME12S.1	52X2	20X1,5	38	12	50	47	54.5	315	4568	S
AFE38SME14S.1	52X2	22X1,5	38	14	50	48.5	56.5	315	4568	S
AFE38SME16S.1	52X2	24X1,5	38	16	50	48	56.5	315	4568	S

DIN FEMALE STANDPIPE REDUCER WITH O-RING-DIN MALE (5)

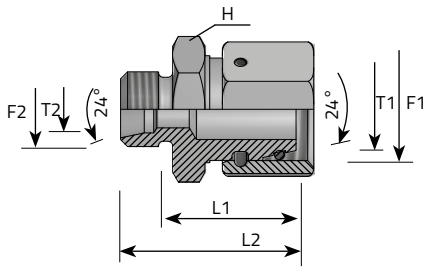

RIDUZIONE FEMMINA GIREVOLE DIN CON O-RING—MASCHIO DIN
 ADAPTEUR DE RÉDUCTION AVEC O-RING
 REDUZIEREINSATZ MIT O-RING ABDICHTUNG – DKOL 24° / MET. 24°
 RACOR DE REDUCCIÓN CON JUNTA TÓRICA

F1 Metrisch, Metrico, Metric, Métrique, Métrico

F2 Metrisch, Metrico, Metric, Métrique, Métrico

Code	Thread		Dimensions					Pressure		Series
	F1	F2	T1	T2	H	L1	L2	Bar	Psi	
			mm							
AFE38SME20S.1	52X2	30X2	38	20	50	48	58.5	315	4568	S
AFE38SME25S.1	52X2	36X2	38	25	50	48.5	60.5	315	4568	S
AFE38SME30S.1	52X2	42X2	38	30	50	49	62.5	315	4568	S

DIN MALE STUD ELBOW-DIN FEMALE WITH O-RING

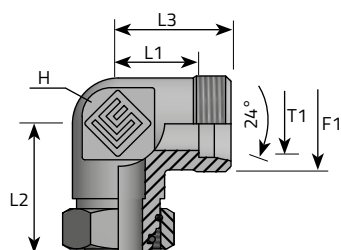

GOMITO 90° MASCHIO DIN – FEMMINA GIREVOLE DIN CON ORING
 COUDE ORIENTABLE – EXÉCUTION FEMELLE AVEC O-RING
 EINSTELLBARER WINKEL-ANSCHLUSSSTUTZEN 90° MIT O-RING – 24°
 METRISCH / DKOL -DKOS
 RACOR EN CODO CON JUNTA TÓRICA

F1 Metrisch, Metrico, Metric, Métrique, Métrico

F2 Metrisch, Metrico, Metric, Métrique, Métrico

Code	Thread		Dimensions					Pressure		Series
	F1	F2	T1	H	L1	L2	L3	Bar	Psi	
			mm	mm	mm	mm	mm			
LME06LFE06L.1	12X1,5	12X1,5	6	12	12	26	19	315	4568	L
LME08LFE08L.1	14X1,5	14X1,5	8	12	14	27,5	19	315	4568	L
LME10LFE10L.1	16X1,5	16X1,5	10	14	15	29	21	315	4568	L
LME12LFE12L.1	18X1,5	18X1,5	12	17	17	29,5	24	315	4568	L
LME15LFE15L.1	22X1,5	22X1,5	15	19	21	32,5	26	315	4568	L
LME18LFE18L.1	26X1,5	26X1,5	18	24	23,5	35,5	31,5	315	4568	L
LME22LFE22L.1	30X2	30X2	22	27	27,5	38,5	34,5	160	2320	L
LME28LFE28L.1	36X2	36X2	28	36	30,5	41,5	43,5	160	2320	L
LME35LFE35L.1	45X2	45X2	35	41	34,5	51	51,5	160	2320	L
LME42LFE42L.1	52X2	52X2	42	50	40	56	61	160	2320	L
LME06SFE06S.1	14X1,5	14X1,5	6	12	16	27	19	630	9137	S
LME08SFE08S.1	16X1,5	16X1,5	8	14	17	27,5	21	630	9137	S
LME10SFE10S.1	18X1,5	18X1,5	10	17	17,5	30	24,5	630	9137	S
LME12SFE12S.1	20X1,5	20X1,5	12	17	21,5	31	24,5	630	9137	S
LME14SFE14S.1	22X1,5	22X1,5	14	19	22	35	27	630	9137	S
LME16SFE16S.1	24X1,5	24X1,5	16	24	24,5	36,5	32,5	400	5801	S
LME20SFE20S.1	30X2	30X2	20	27	26,5	44,5	37,5	400	5801	S
LME25SFE25S.1	36X2	36X2	25	36	30	50	48	400	5801	S
LME30SFE30S.1	42X2	42X2	30	41	35,5	55	54,5	400	5801	S
LME38SFE38S.1	52X2	52X2	38	50	41	63	66	315	4568	S

T ADPT DIN MALE/DIN MALE/DIN FEMALE WITH O-RING

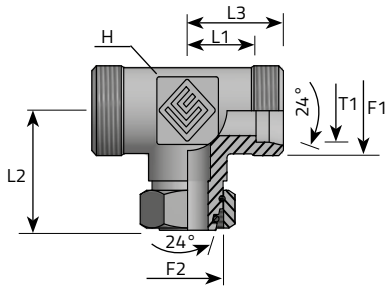

ADATTATORE T MASCHIO DIN -FEMMINA DIN AL PIEDE CON O-RING
 TÉ ORIENTABLE. EXÉCUTION FEMELLE AVEC O-RING
 EINSTELLBARE T MIT O-RING -ANSCHLUSSSTUTZEN – 2 X DIN 24° /
 DKOL-DKOS UNTEN
 RACOR EN T TUBO – TUBO CON JUNTA TÓRICA

F1 Metrisch, Metrico, Metric, Métrique, Métrico

F2 Metrisch, Metrico, Metric, Métrique, Métrico

Code	Thread		Dimensions					Pressure		Series
	F1	F2	T1	H	L1	L2	L3	Bar	Psi	
			mm	mm	mm	mm	mm			
TME06LFE06LP.1	12X1,5	12X1,5	6	12	12	26	19	315	4568	L
TME08LFE08LP.1	14X1,5	14X1,5	8	12	14	27,5	21	315	4568	L
TME10LFE10LP.1	16X1,5	16X1,5	10	14	15	29	22	315	4568	L
TME12LFE12LP.1	18X1,5	18X1,5	12	17	17	29,5	24	315	4568	L
TME15LFE15LP.1	22X1,5	22X1,5	15	19	21	32,5	28	315	4568	L
TME18LFE18LP.1	26X1,5	26X1,5	18	24	23,5	35,5	31	315	4568	L
TME22LFE22LP.1	30X2	30X2	22	27	27,5	38,5	35	160	2320	L
TME28LFE28LP.1	36X2	36X2	28	36	30,5	41,5	38	160	2320	L
TME35LFE35LP.1	45X2	45X2	35	41	34,5	51	45	160	2320	L
TME42LFE42LP.1	52X2	52X2	42	50	40	56	51	160	2320	L
TME06SFE06SP.1	14X1,5	14X1,5	6	12	16	27	23	630	9137	S
TME08SFE08SP.1	16X1,5	16X1,5	8	14	17	27,5	24	630	9137	S
TME10SFE10SP.1	18X1,5	18X1,5	10	17	17,5	30	25	630	9137	S
TME12SFE12SP.1	20X1,5	20X1,5	12	17	21,5	31	29	630	9137	S
TME14SFE14SP.1	22X1,5	22X1,5	14	19	22	35	30	630	9137	S
TME16SFE16SP.1	24X1,5	24X1,5	16	24	24,5	36,5	33	400	5801	S
TME20SFE20SP.1	30X2	30X2	20	27	26,5	44,5	37	400	5801	S
TME25SFE25SP.1	36X2	36X2	25	36	30	50	42	400	5801	S
TME30SFE30SP.1	42X2	42X2	30	41	35,5	55	49	400	5801	S
TME38SFE38SP.1	52X2	52X2	38	50	41	63	57	315	4568	S

T ADAPTER DIN MALE/DIN FEMALE WITH O-RING/DIN MALE

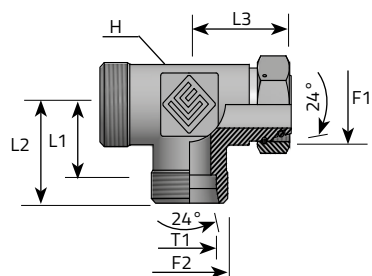

ADATTATORE T MASCHIO DIN - FEMMINA DIN AL BRACCIO CON O-RING
 TÉ ORIENTABLE. EXÉCUTION FEMELLE AVEC O-RING
 EINSTELLBARER T MIT O-RING-ANSCHLUSSSTUTZEN – 2 X DIN 24° /
 DKOL-DKOS SEITLICH
 RACOR EN T TUBO – TUBO CON JUNTA TÓRICA

F1 Metrisch, Metrico, Metric, Métrique, Métrico

F2 Metrisch, Metrico, Metric, Métrique, Métrico

Code	Thread		Dimensions					Pressure		Series
	F1	F2	T1	H	L1	L2	L3	Bar	Psi	
			mm	mm	mm	mm	mm			
TME06LFE06LB.1	12X1,5	12X1,5	6	12	12	26	19	315	4568	L
TME08LFE08LB.1	14X1,5	14X1,5	8	12	14	27,5	21	315	4568	L
TME10LFE10LB.1	16X1,5	16X1,5	10	14	15	29	22	315	4568	L
TME12LFE12LB.1	18X1,5	18X1,5	12	17	17	29,5	24	315	4568	L
TME15LFE15LB.1	22X1,5	22X1,5	15	19	21	32,5	28	315	4568	L
TME18LFE18LB.1	26X1,5	26X1,5	18	24	23,5	35,5	31	315	4568	L
TME22LFE22LB.1	30X2	30X2	22	27	27,5	38,5	35	160	2320	L
TME28LFE28LB.1	36X2	36X2	28	36	30,5	41,5	38	160	2320	L
TME35LFE35LB.1	45X2	45X2	35	41	34,5	51	45	160	2320	L
TME42LFE42LB.1	52X2	52X2	42	50	40	56	51	160	2320	L
TME06SFE06SB.1	14X1,5	14X1,5	6	12	16	27	23	630	9137	S
TME08SFE08SB.1	16X1,5	16X1,5	8	14	17	27,5	24	630	9137	S
TME10SFE10SB.1	18X1,5	18X1,5	10	17	17,5	30	25	630	9137	S
TME12SFE12SB.1	20X1,5	20X1,5	12	17	21,5	31	29	630	9137	S
TME14SFE14SB.1	22X1,5	22X1,5	14	19	22	35	30	630	9137	S
TME16SFE16SB.1	24X1,5	24X1,5	16	24	24,5	36,5	33	400	5801	S
TME20SFE20SB.1	30X2	30X2	20	27	26,5	44,5	37	400	5801	S
TME25SFE25SB.1	36X2	36X2	25	36	30	50	42	400	5801	S
TME30SFE30SB.1	42X2	42X2	30	41	35,5	55	49	400	5801	S
TME38SFE38SB.1	52X2	52X2	38	50	41	63	57	315	4568	S

DIN MALE-DIN STANDPIPE TUBE REDUCER (1)

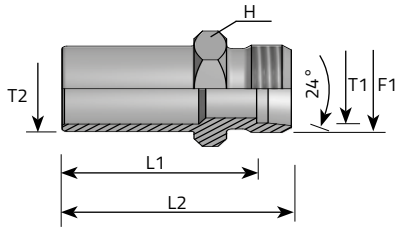

ADATTATORE MASCHIO DIN - TUBO DIN
 ADAPTEUR DE RÉDUCTION
 REDUZIEREINSATZ – METRISCH 24° / BEL-BES
 RACOR DE REDUCCIÓN

F1 Metrisch, Metrico, Metric, Métrique, Métrico

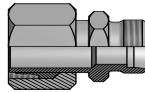

Note: AME06LTL08.1 for body only
 AME06LTL08.3 for nut and cutting ring included

Code	Thread	Dimensions					Pressure		Series	
		F1	T1	T2	H	L1	L2	Bar		Psi
			mm	mm	mm	mm	mm			
AME06LTL08.1	12X1.5	6	8	12	25,5	32,5	315	4568	L	
AME06LTL10.1	12X1.5	6	10	12	26	33	315	4568	L	
AME06LTL12.1	12X1.5	6	12	14	27	34	315	4568	L	
AME06LTL15.1	12X1.5	6	15	17	27	34	315	4568	L	
AME06LTL18.1	12X1.5	6	18	19	29,5	36,5	315	4568	L	
AME06LTL22.1	12X1.5	6	22	24	30,5	37,5	160	2320	L	
AME06LTL28.1	12X1.5	6	28	30	32	39	160	2320	L	
AME06LTL35.1	12X1.5	6	35	36	38,5	45,5	160	2320	L	
AME06LTL42.1	12X1.5	6	42	46	39,5	46,5	160	2320	L	
AME08LTL10.1	14X1.5	8	10	14	27	34	315	4568	L	
AME08LTL12.1	14X1.5	8	12	14	27	34	315	4568	L	
AME08LTL15.1	14X1.5	8	15	17	27	34	315	4568	L	
AME08LTL18.1	14X1.5	8	18	19	29,5	36,5	315	4568	L	
AME08LTL22.1	14X1.5	8	22	24	30,5	37,5	160	2320	L	
AME08LTL28.1	14X1.5	8	28	30	32	39	160	2320	L	
AME08LTL35.1	14X1.5	8	35	36	38,5	45,5	160	2320	L	
AME08LTL42.1	14X1.5	8	42	46	39,5	46,5	160	2320	L	
AME10LTL12.1	16X1.5	10	12	17	28	35	315	4568	L	
AME10LTL15.1	16X1.5	10	15	17	28	35	315	4568	L	
AME10LTL18.1	16X1.5	10	18	19	30,5	37,5	315	4568	L	

DIN MALE-DIN STANDPIPE TUBE REDUCER (2)

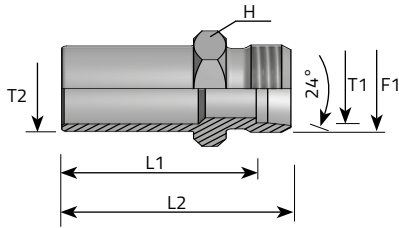

ADATTATORE MASCHIO DIN - TUBO DIN
 ADAPTEUR DE RÉDUCTION
 REDUZIEREINSATZ – METRISCH 24° / BEL-BES
 RACOR DE REDUCCIÓN

F1 Metrisch, Metrico, Metric, Métrique, Métrico

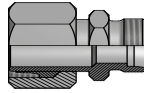

Note: AME06LTL08.1 for body only
 AME06LTL08.3 for nut and cutting ring included

Code	Thread	Dimensions					Pressure		Series	
		F1	T1	T2	H	L1	L2	Bar		Psi
			mm	mm	mm	mm	mm			
AME10LTL22.1	16X1.5		10	22	24	31,5	38,5	160	2320	L
AME10LTL28.1	16X1.5		10	28	30	33	40	160	2320	L
AME10LTL35.1	16X1.5		10	35	36	39,5	46,5	160	2320	L
AME10LTL42.1	16X1.5		10	42	46	40,5	47,5	160	2320	L
AME12LTL15.1	18x1.5		12	15	19	29	36	315	4568	L
AME12LTL18.1	18x1.5		12	18	19	30.5	37.5	315	4568	L
AME12LTL22.1	18x1.5		12	22	24	31.5	38.5	160	2320	L
AME12LTL28.1	18x1.5		12	28	30	33	40	160	2320	L
AME12LTL35.1	18x1.5		12	35	36	39.5	46.5	160	2320	L
AME12LTL42.1	18x1.5		12	42	46	40.5	47.5	160	2320	L
AME15LTL18.1	22x1.5		15	18	24	31.5	38.5	315	4568	L
AME15LTL22.1	22x1.5		15	22	24	32.5	39.5	160	2320	L
AME15LTL28.1	22x1.5		15	28	30	34	41	160	2320	L
AME15LTL35.1	22x1.5		15	35	36	40.5	47.5	160	2320	L
AME15LTL42.1	22x1.5		15	42	46	41.5	48.5	160	2320	L
AME18LTL22.1	26x1.5		18	22	27	32.5	40	160	2320	L
AME18LTL28.1	26x1.5		18	28	30	33.5	41	160	2320	L
AME18LTL35.1	26x1.5		18	35	36	40	47.5	160	2320	L
AME18LTL42.1	26x1.5		18	42	46	41	48.5	160	2320	L
AME22LTL28.1	30x2		22	28	32	35.5	43	160	2320	L

DIN MALE-DIN STANDPIPE TUBE REDUCER (3)

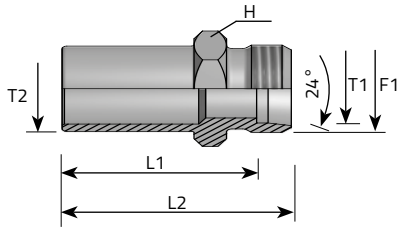

ADATTATORE MASCHIO DIN - TUBO DIN
 ADAPTEUR DE RÉDUCTION
 REDUZIEREINSATZ – METRISCH 24° / BEL-BES
 RACOR DE REDUCCIÓN

F1 Metrisch, Metrico, Metric, Métrique, Métrico

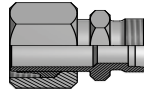

Note: AME06LTLO8.1 for body only
 AME06LTLO8.3 for nut and cutting ring included

Code	Thread	Dimensions					Pressure		Series	
		F1	T1	T2	H	L1	L2	Bar		Psi
			mm	mm	mm	mm	mm			
AME22LTL35.1	30x2		22	35	36	42	49.5	160	2320	L
AME22LTL42.1	30x2		22	42	46	43	50.5	160	2320	L
AME28LTL35.1	36x2		28	35	41	42	49.5	160	2320	L
AME28LTL42.1	36x2		28	42	46	43	50.5	160	2320	L
AME35LTL42.1	45x2		35	42	46	42	52.5	160	2320	L
AME06STS08.1	14X1.5		6	8	14	29	36	630	9137	S
AME06STS10.1	14X1.5		6	10	14	31,5	38,5	630	9137	S
AME06STS12.1	14X1.5		6	12	14	31	38	630	9137	S
AME06STS14.1	14X1.5		6	14	17	35	42	630	9137	S
AME06STS16.1	14X1.5		6	16	17	36	43	400	5801	S
AME06STS20.1	14X1.5		6	20	22	41,5	48,5	400	5801	S
AME06STS25.1	14X1.5		6	25	27	44	51	400	5801	S
AME06STS30.1	14X1.5		6	30	32	48,5	55,5	400	5801	S
AME06STS38.1	14X1.5		6	38	41	54	61,5	315	4568	S
AME08STS10.1	16X1.5		8	10	17	33,5	40,5	630	9137	S
AME08STS12.1	16X1.5		8	12	17	33	40	630	9137	S
AME08STS14.1	16X1.5		8	14	17	35	42	630	9137	S
AME08STS16.1	16X1.5		8	16	17	36	43	400	5801	S
AME08STS20.1	16X1.5		8	20	22	41	48,5	400	5801	S
AME08STS25.1	16X1.5		8	25	27	44	51	400	5801	S

DIN MALE-DIN STANDPIPE TUBE REDUCER (4)

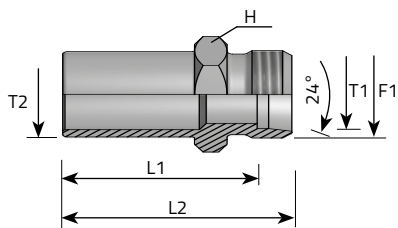

ADATTATORE MASCHIO DIN - TUBO DIN
 ADAPTEUR DE RÉDUCTION
 REDUZIEREINSATZ – METRISCH 24° / BEL-BES
 RACOR DE REDUCCIÓN

F1 Metrisch, Metrico, Metric, Métrique, Métrico

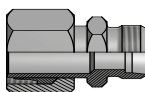

Note: AME06LT08.1 for body only
 AME06LT08.3 for nut and cutting ring included

Code	Thread	Dimensions					Pressure		Series	
		F1	T1	T2	H	L1	L2	Bar		Psi
			mm	mm	mm	mm	mm			
AME08STS30.1	16X1.5		8	30	32	48,5	55,5	400	5801	S
AME08STS38.1	16X1.5		8	38	41	54,5	61,5	315	4568	S
AME10STS12.1	18X1.5		10	12	19	32,5	40	630	9137	S
AME10STS14.1	18X1.5		10	14	19	34,5	42	630	9137	S
AME10STS16.1	18X1.5		10	16	19	35,5	43	400	5801	S
AME10STS20.1	18X1.5		10	20	22	41	48,5	400	5801	S
AME10STS25.1	18X1.5		10	25	27	43,5	51	400	5801	S
AME10STS30.1	18X1.5		10	30	32	48	55,5	400	5801	S
AME10STS38.1	18X1.5		10	38	41	54	61,5	315	4568	S
AME12STS14.1	20X1.5		12	14	22	36,5	44	630	9137	S
AME12STS16.1	20X1.5		12	16	22	37,5	45	400	5801	S
AME12STS20.1	20X1.5		12	20	22	41	48,5	400	5801	S
AME12STS25.1	20X1.5		12	25	27	43,5	51	400	5801	S
AME12STS30.1	20X1.5		12	30	32	48	55,5	400	5801	S
AME12STS38.1	20X1.5		12	38	41	54	61,5	315	4568	S
AME14STS16.1	22X1.5		14	16	24	39	47	400	5801	S
AME14STS20.1	22X1.5		14	20	24	42,5	50,5	400	5801	S
AME14STS25.1	22X1.5		14	25	27	45	53	400	5801	S
AME14STS30.1	22X1.5		14	30	32	49,5	57,5	400	5801	S
AME14STS38.1	22X1.5		14	38	41	55,5	63,5	315	4568	S

DIN MALE-DIN STANDPIPE TUBE REDUCER (5)

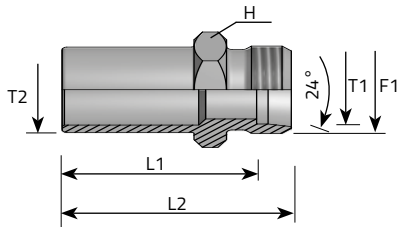

ADATTATORE MASCHIO DIN - TUBO DIN
 ADAPTEUR DE RÉDUCTION
 REDUZIEREINSATZ – METRISCH 24° / BEL-BES
 RACOR DE REDUCCIÓN

F1 Metrisch, Metrico, Metric, Métrique, Métrico

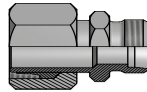

Note: AME06LTL08.1 for body only
 AME06LTL08.3 for nut and cutting ring included

Code	Thread	Dimensions					Pressure		Series	
		F1	T1	T2	H	L1	L2	Bar		Psi
			mm	mm	mm	mm	mm			
AME16STS20.1	24X1.5		16	20	27	42	50,5	400	5801	S
AME16STS25.1	24X1.5		16	25	27	44,5	53	400	5801	S
AME16STS30.1	24X1.5		16	30	32	49	57,5	400	5801	S
AME16STS38.1	24X1.5		16	38	41	55	63,5	315	4568	S
AME20STS25.1	30X2		20	25	32	46,5	57	400	5801	S
AME20STS30.1	30X2		20	30	32	49	59,5	400	5801	S
AME20STS38.1	30X2		20	38	41	55	65,5	315	4568	S
AME25STS30.1	36X2		25	30	41	51,5	63,5	400	5801	S
AME25STS38.1	36X2		25	38	41	55	67,5	315	4568	S
AME30STS38.1	42X2		30	38	46	56	69,5	315	4568	S

DIN MALE STUD ELBOW-DIN STANDPIPE

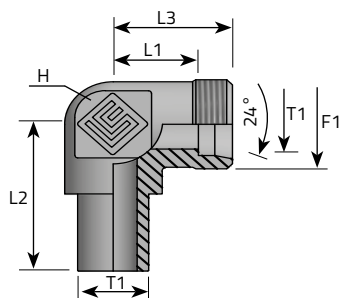

GOMITO 90° MASCHIO DIN – TUBO DIN
 COUDE ORIENTABLE – EXÉCUTION FEMELLE
 EINSTELLBARER WINKEL-ANSCHLUSSSTUTZEN 90° – 24° METRISCH /
 BEL-BES
 RACOR EN CODO REGULABLE

F1 Metrisch, Metrico, Metric, Métrique, Métrico

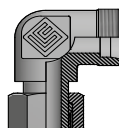

Note: LME06LTLO8.1 for body only
 LME06LTLO8.3 for nut and cutting ring included

Code	Thread	Dimensions					Pressure		Series
		T1	H	L1	L2	L3	Bar	Psi	
	F1	mm	mm	mm	mm	mm			
LME06LTLO6.1	12X1,5	6	12	12	26	19	315	4568	L
LME08LTLO8.1	14X1,5	8	12	14	27,5	21	315	4568	L
LME10LTLO10.1	16X1,5	10	14	15	29	22	315	4568	L
LME12LTLO12.1	18X1,5	12	17	17	29,5	24	315	4568	L
LME15LTLO15.1	22X1,5	15	19	21	32,5	28	315	4568	L
LME18LTLO18.1	26X1,5	18	24	23,5	35,5	31	315	4568	L
LME22LTLO22.1	30X2	22	27	27,5	38,5	35	160	2320	L
LME28LTLO28.1	36X2	28	36	30,5	41,5	38	160	2320	L
LME35LTLO35.1	45X2	35	41	34,5	51	45	160	2320	L
LME42LTLO42.1	52X2	42	50	40	56	51	160	2320	L
LME06STSO6.1	14X1,5	6	12	16	27	23	630	9137	S
LME08STSO8.1	16X1,5	8	14	17	27,5	24	630	9137	S
LME10STSO10.1	18X1,5	10	17	17,5	30	25	630	9137	S
LME12STSO12.1	20X1,5	12	17	21,5	31	29	630	9137	S
LME14STSO14.1	22X1,5	14	19	22	35	30	630	9137	S
LME16STSO16.1	24X1,5	16	24	24,5	36,5	33	400	5801	S
LME20STSO20.1	30X2	20	27	26,5	44,5	37	400	5801	S
LME25STSO25.1	36X2	25	36	30	50	42	400	5801	S
LME30STSO30.1	42X2	30	41	35,5	55	49	400	5801	S
LME38STSO38.1	52X2	38	50	41	63	57	315	4568	S

T ADAPTER DIN STANDPIPE/DIN MALE/DIN MALE

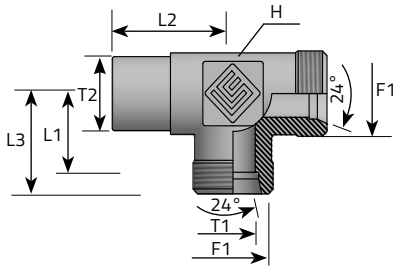

ADATTATORE T MASCHIO DIN – TUBO AL BRACCIO
 TÉ RENSERVÉ ORIENTABLE EXÉCUTION – FEMELLE
 EINSTELLBARER T-ANSCHLUSSSTUTZEN – 2 X DIN / BEL-BES UNTEN
 (MIT UND OHNE MUTTER + SCHNEIDRING)
 RACOR EN T REGULABLE

F1 Metrisch, Metrico, Metric, Métrique, Métrico

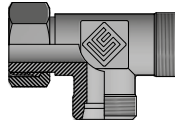

Note: TME06LTL06B.1 for body only
 TME06LTL06B.3 for nut and cutting ring included

Code	Thread		Dimensions						Pressure		Series
	F1	F2	T1	T2	H	L1	L2	L3	Bar	Psi	
			mm	mm	mm	mm	mm	mm			
TME06LTL06B.1	12X1,5	12X1,5	6	6	12	12	26	19	315	4568	L
TME08LTL08B.1	14X1,5	14X1,5	8	8	12	14	27,5	21	315	4568	L
TME10LTL10B.1	16X1,5	16X1,5	10	10	14	15	29	22	315	4568	L
TME12LTL12B.1	18X1,5	18X1,5	12	12	17	17	29,5	24	315	4568	L
TME15LTL15B.1	22X1,5	22X1,5	15	15	19	21	32,5	28	315	4568	L
TME18LTL18B.1	26X1,5	26X1,5	18	18	24	23,5	35,5	31	315	4568	L
TME22LTL22B.1	30X2	30X2	22	22	27	27,5	38,5	35	160	2320	L
TME28LTL28B.1	36X2	36X2	28	28	36	30,5	41,5	38	160	2320	L
TME35LTL35B.1	45X2	45X2	35	35	41	34,5	51	45	160	2320	L
TME42LTL42B.1	52X2	52X2	42	42	50	40	56	51	160	2320	L
TME06STS06B.1	14X1,5	14X1,5	6	6	12	16	27	23	630	9137	S
TME08STS08B.1	16X1,5	16X1,5	8	8	14	17	27,5	24	630	9137	S
TME10STS10B.1	18X1,5	18X1,5	10	10	17	17,5	30	25	630	9137	S
TME12STS12B.1	20X1,5	20X1,5	12	12	17	21,5	31	29	630	9137	S
TME14STS14B.1	22X1,5	22X1,5	14	14	19	22	35	30	630	9137	S
TME16STS16B.1	24X1,5	24X1,5	16	16	24	24,5	36,5	33	400	5801	S
TME20STS20B.1	30X2	30X2	20	20	27	26,5	44,5	37	400	5801	S
TME25STS25B.1	36X2	36X2	25	25	36	30	50	42	400	5801	S
TME30STS30B.1	42X2	42X2	30	30	41	35,5	55	49	400	5801	S
TME38STS38B.1	52X2	52X2	38	38	50	41	63	57	315	4568	S

T ADAPTER DIN MALE/DIN MALE/DIN STANDPIPE

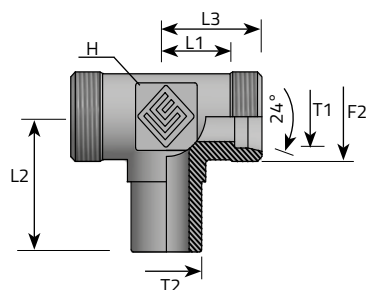

ADATTATORE T MASCHIO DIN – TUBO DIN AL PIEDE
TÉ REDUCTION
 EINSTELLBARER T-ANSCHLUSSSTUTZEN – 2 X DIN / BEL-BES UNTEN
 (MIT UND OHNE MUTTER + SCHNEIDRING)
RACOR UNION EN T TUBO – TUBO

F1 Metrisch, Metrico, Metric, Métrique, Métrico

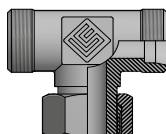

*Note: TME06LTLO6P.1 for body only
 TME06LTLO6P.3 for nut and cutting ring included*

Code	Thread	Dimensions						Pressure		Series	
		F1	T1	T2	H	L1	L2	L3	Bar		Psi
			mm	mm	mm	mm	mm	mm			
TME06LTLO6P.1	12X1,5		6	6	12	12	26	19	315	4568	L
TME08LTLO8P.1	14X1,5		8	8	12	14	27,5	21	315	4568	L
TME10LTLO10P.1	16X1,5		10	10	14	15	29	22	315	4568	L
TME12LTLO12P.1	18X1,5		12	12	17	17	29,5	24	315	4568	L
TME15LTLO15P.1	22X1,5		15	15	19	21	32,5	28	315	4568	L
TME18LTLO18P.1	26X1,5		18	18	24	23,5	35,5	31	315	4568	L
TME22LTLO22P.1	30X2		22	22	27	27,5	38,5	35	160	2320	L
TME28LTLO28P.1	36X2		28	28	36	30,5	41,5	38	160	2320	L
TME35LTLO35P.1	45X2		35	35	41	34,5	51	45	160	2320	L
TME42LTLO42P.1	52X2		42	42	50	40	56	51	160	2320	L
TME06STS06P.1	14X1,5		6	6	12	16	27	23	630	9137	S
TME08STS08P.1	16X1,5		8	8	14	17	27,5	24	630	9137	S
TME10STS10P.1	18X1,5		10	10	17	17,5	30	25	630	9137	S
TME12STS12P.1	20X1,5		12	12	17	21,5	31	29	630	9137	S
TME14STS14P.1	22X1,5		14	14	19	22	35	30	630	9137	S
TME16STS16P.1	24X1,5		16	16	24	24,5	36,5	33	400	5801	S
TME20STS20P.1	30X2		20	20	27	26,5	44,5	37	400	5801	S
TME25STS25P.1	36X2		25	25	36	30	50	42	400	5801	S
TME30STS30P.1	42X2		30	30	41	35,5	55	49	400	5801	S
TME38STS38P.1	52X2		38	38	50	41	63	57	315	4568	S

DIN FEMALE SWIVEL WITH O-RING-DIN FEMALE SWIVEL WITH O-RING

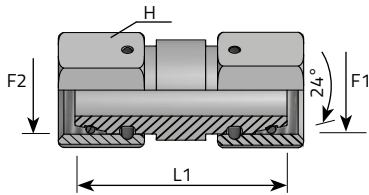

ADATTATORE DIRITTO FEMMINA GIREVOLE CON O-RING- FEMMINA
GIREVOLE CON O-RING
RACCORD INTERMÉDIAIRE DROIT AVEC JOINT TORIQUE AVEC O-RING
GERADER VERBINDER MIT O-RING – DKOL 24° / DKOL 24°
RACOR UNIÓN RECTA CON JUNTA TÓRICA

F1 Metrisch, Metrico, Metric, Métrique, Métrico

F2 Metrisch, Metrico, Metric, Métrique, Métrico

Code	Thread		Dimensions			Pressure		Series
	F1	F2	T	H	L1	Bar	Psi	
			mm	mm	mm	L/S		
AFE06L	12X1,5	12X1,5	6	12	34	315	4568	L
AFE08L	14X1,5	14X1,5	8	14	34	315	4568	L
AFE10L	16X1,5	16X1,5	10	14	36	315	4568	L
AFE12L	18X1,5	18X1,5	12	19	36	315	4568	L
AFE15L	22X1,5	22X1,5	15	22	39	315	4568	L
AFE18L	26X1,5	26X1,5	18	24	40,5	315	4568	L
AFE22L	30X2	30X2	22	27	45	160	2320	L
AFE28L	36X2	36X2	28	36	47	160	2320	L
AFE35L	45X2	45X2	35	46	53	160	2320	L
AFE42L	52X2	52X2	42	50	53	160	2320	L
AFE06S	14X1,5	14X1,5	6	14	37	630	9137	S
AFE08S	16X1,5	16X1,5	8	14	37	630	9137	S
AFE10S	18X1,5	18X1,5	10	19	41	630	9137	S
AFE12S	20X1,5	20X1,5	12	19	42	630	9137	S
AFE14S	22X1,5	22X1,5	14	22	45	630	9137	S
AFE16S	24X1,5	24X1,5	16	22	46	400	5801	S
AFE20S	30X2	30X2	20	27	55	400	5801	S
AFE25S	36X2	36X2	25	36	58	400	5801	S
AFE30S	42X2	42X2	30	46	62	400	5801	S
AFE38S	52X2	52X2	38	50	67	315	4568	S

DIN MALE STUD COUPLING-BSPF FEMALE

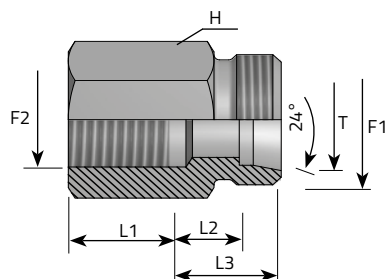

ADATTATORE DIRITTO MASCHIO DIN – FEMMINA FISSA GAS CILINDRICA
 FEMALE STUD COUPLING
 GERADE AUFSCHRAUBVERSCHRAUBUNG – METRISCH 24° / DKR-Z
 RACOR RECTO MACHO-HEMBRA

F1 Metrisch, Metrico, Metric, Métrique, Métrico

F2 Zylinder-Gasgewinde, Gas cilíndrico, BSPP, Gaz cylíndrique,
 Gas cilíndrica

Code	Thread		Dimensions					Pressure		Series
	F1	F2	T1	H	L1	L2	L3	Bar	Psi	
			mm	mm	mm	mm	mm			
AME06LFFG02.1	12x1,5	1/8"	6	14	10	9	16	315	4568	L
AME08LFFG04.1	14x1,5	1/4"	8	19	14	10	17	315	4568	L
AME10LFFG04.1	16x1,5	1/4"	10	19	14	11	18	315	4568	L
AME12LFFG06.1	18x1,5	3/8"	12	24	14	12	19	315	4568	L
AME15LFFG08.1	22x1,5	1/2"	15	27	17	14	21	315	4568	L
AME18LFFG08.1	26x1,5	1/2"	18	27	17	13,5	21	315	4568	L
AME22LFFG12.1	30x2	3/4"	22	36	19	16,5	24	160	2320	L
AME28LFFG16.1	36x2	1"	28	41	21,5	16	23,5	160	2320	L
AME35LFFG20.1	45x2	1.1/4"	35	55	23,5	18	28,5	160	2320	L
AME42LFFG24.1	52x2	1.1/2"	42	60	25,5	17,5	28,5	160	2320	L
AME06SFFG04.1	14x1,5	1/4"	6	19	14	12	19	630	9137	S
AME08SFFG04.1	16x1,5	1/4"	8	19	14	12	19	630	9137	S
AME10SFFG06.1	18x1,5	3/8"	10	24	14	12,5	20	630	9137	S
AME12SFFG06.1	20x1,5	3/8"	12	24	14	12,5	20	630	9137	S
AME14SFFG08.1	22x1,5	1/2"	14	30	17	15	23	630	9137	S
AME16SFFG08.1	24x1,5	1/2"	16	30	17	14,5	23	400	5801	S
AME20SFFG12.1	30x2	3/4"	20	36	19	15,5	26	400	5801	S
AME25SFFG16.1	36x2	1"	25	41	21,5	15,5	27,5	400	5801	S
AME30SFFG20.1	42x2	1.1/4"	30	55	23,5	19	32,5	400	5801	S
AME38SFFG24.1	52x2	1.1/2"	38	60	25,5	18,5	34,5	315	4568	S

DIN MALE STUD COUPLING-METRIC FEMALE

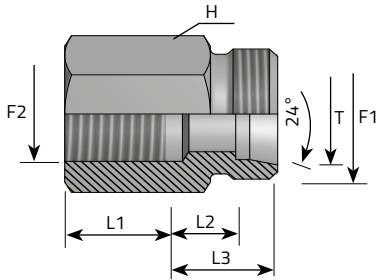

ADATTATORE DIRITTO MASCHIO DIN – FEMMINA FISSA METRICA
FEMALE STUD COUPLING
 GERADE AUFSCHRAUBVERSCHRAUBUNG – METRISCH 24° / METRISCH-
 ZYLINDRISCH
RACOR RECTO MACHO-HEMBRA

F1 Metrisch, Metrico, Metric, Métrique, Métrico

F2 Metrisch, Metrico, Metric, Métrique, Métrico

Code	Thread		Dimensions					Pressure		Series
	F1	F2	T	H	L1	L2	L3	Bar	Psi	
			mm	mm	mm	mm	mm			
AME06LFFM10.1	12x1,5	10x1	6	14	10	9	16	315	4568	L
AME08LFFM12.1	14x1,5	12x1,5	8	17	14,5	9,5	16,5	315	4568	L
AME10LFFM14.1	16x1,5	14x1,5	10	19	14,5	10,5	17,5	315	4568	L
AME10LFFM16.1	16x1,5	16x1,5	10	22	14,5	11,5	18,5	315	4568	L
AME12LFFM16.1	18x1,5	16x1,5	12	22	14,5	11,5	18,5	315	4568	L
AME15LFFM18.1	22x1,5	18x1,5	15	24	14,5	16,5	23,5	315	4568	L
AME18LFFM22.1	26x1,5	22x1,5	18	30	16,5	14	21,5	315	4568	L
AME22LFFM26.1	30x2	26x1,5	22	32	18,5	16	23,5	160	2320	L
AME28LFFM33.1	36x2	33x2	28	41	21	16,5	24	160	2320	L
AME35LFFM42.1	45x2	42x2	35	55	23	17,5	28	160	2320	L
AME42LFFM48.1	52x2	48x2	42	60	25	18	29	160	2320	L
AME06SFFM12.1	14x1,5	12x1,5	6	17	14,5	11,5	18,5	630	9137	S
AME08SFFM14.1	16x1,5	14x1,5	8	19	14,5	11,5	18,5	630	9137	S
AME10SFFM16.1	18x1,5	16x1,5	10	22	14,5	12	19,5	630	9137	S
AME12SFFM18.1	20x1,5	18x1,5	12	24	14,5	12	19,5	630	9137	S
AME14SFFM20.1	22x1,5	20x1,5	14	27	16,5	15,5	23,5	630	9137	S
AME16SFFM22.1	24x1,5	22x1,5	16	30	16,5	15	23,5	400	5801	S
AME20SFFM27.1	30x2	27x2	20	36	19	15,5	26	400	5801	S
AME25SFFM33.1	36x2	33x2	25	41	21	16	28	400	5801	S
AME30SFFM42.1	42x2	42x2	30	55	23	19,5	33	400	5801	S
AME38SFFM48.1	52x2	48x2	38	60	25	19	35	315	4568	S

DIN MALE STUD COUPLING - BSPP MALE FORM B (1)

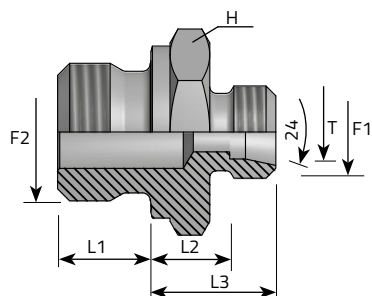

ADATTATORE DIRITTO M. DIN - M.GAS CILINDRICO FORMA B DIN 3852
 UNION SIMPLE MÂLE BSPP FORME B DIN 3852
 GERADE EINSCHRAUBVERSCHRAUBUNG FORM B
 DIN 3852 – METRISCH 24° / AGR-Z
 RACOR RECTO BSPP FORMA B DIN 3852

F1 Metrisch, Metrico, Metric, Métrique, Métrico

F2 Zylinder-Gasgewinde, Gas cilíndrico, BSPP, Gaz cylíndrique,
 Gas cilíndrica

Code	Thread		Dimensions					Pressure		Series
	F1	F2	T	H	L1	L2	L3	Bar	Psi	
			mm	mm	mm	mm	mm			
AME06LMG02.1	12X1,5	1/8"	6	14	8	8,5	15,5	315	4568	L
AME06LMG04.1	12X1,5	1/4"	6	19	12	10	17	315	4568	L
AME06LMG06.1	12X1,5	3/8"	6	22	12	11,5	18,5	315	4568	L
AME06LMG08.1	12X1,5	1/2"	6	27	14	12	19	315	4568	L
AME08LMG02.1	14X1,5	1/8"	8	14	8	8,5	15,5	315	4568	L
AME08LMG04.1	14X1,5	1/4"	8	19	12	10	17	315	4568	L
AME08LMG06.1	14X1,5	3/8"	8	22	12	11,5	18,5	315	4568	L
AME08LMG08.1	14X1,5	1/2"	8	27	14	12	19	315	4568	L
AME10LMG02.1	16X1,5	1/8"	10	17	8	10,5	18	315	4568	L
AME10LMG04.1	16X1,5	1/4"	10	19	12	11	18,5	315	4568	L
AME10LMG06.1	16X1,5	3/8"	10	22	12	12,5	20	315	4568	L
AME10LMG08.1	16X1,5	1/2"	10	27	14	13	20,5	315	4568	L
AME12LMG04.1	18X1,5	1/4"	12	19	12	12	19,5	315	4568	L
AME12LMG06.1	18X1,5	3/8"	12	22	12	12,5	20	315	4568	L
AME12LMG08.1	18X1,5	1/2"	12	27	14	13	20,5	315	4568	L
AME12LMG12.1	18X1,5	3/4"	12	32	16	14	21,5	315	4568	L
AME15LMG06.1	22X1,5	3/8"	15	24	12	13,5	21	315	4568	L
AME15LMG08.1	22X1,5	1/2"	15	27	14	14	21,5	315	4568	L
AME15LMG12.1	22X1,5	3/4"	15	32	16	15	22,5	315	4568	L
AME18LMG06.1	26X1,5	3/8"	18	27	12	14	21,5	315	4568	L
AME18LMG08.1	26X1,5	1/2"	18	27	14	14,5	22	315	4568	L
AME18LMG12.1	26X1,5	3/4"	18	32	16	14,5	22	315	4568	L
AME22LMG08.1	30X2	1/2"	22	32	14	16,5	24	160	2320	L

DIN MALE STUD COUPLING - BSPP MALE FORM B (2)

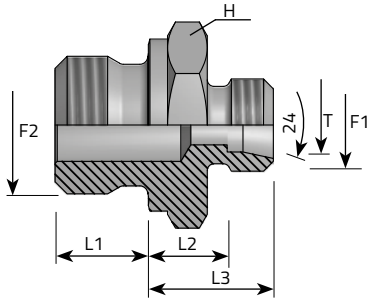

ADATTATORE DIRITTO M. DIN - M.GAS CILINDRICO FORMA B DIN 3852
 UNION SIMPLE MÂLE BSPP FORME B DIN 3852
 GERADE EINSCHRAUBVERSCHRAUBUNG FORM B
 DIN 3852 – METRISCH 24° / AGR-Z
 RACOR RECTO BSPP FORMA B DIN 3852

F1 Metrisch, Metrico, Metric, Métrique, Métrico

F2 Zylinder-Gasgewinde, Gas cilíndrico, BSPP, Gaz cylíndrique, Gas cilíndrica

Code	Thread		Dimensions					Pressure		Series
	F1	F2	T	H	L1	L2	L3	Bar	Psi	
			mm	mm	mm	mm	mm			
AME22LMG12.1	30X2	3/4"	22	32	16	16,5	24	160	2320	L
AME22LMG16.1	30X2	1"	22	41	18	17,5	25	160	2320	L
AME28LMG12.1	36X2	3/4"	28	41	16	17,5	25	160	2320	L
AME28LMG16.1	36X2	1"	28	41	18	17,5	25	160	2320	L
AME35LMG16.1	45X2	1"	35	46	18	17,5	28	160	2320	L
AME35LMG20.1	45X2	1.1/4"	35	50	20	17,5	28	160	2320	L
AME42LMG20.1	52x2	1.1/4"	42	55	20	19	30	160	2320	L
AME42LMG24.1	52X2	1.1/2"	42	55	22	19	30	160	2320	L
AME06SMG04.1	14X1,5	1/4"	6	19	12	13	20	630	9137	S
AME06SMG08.1	14X1,5	1/2"	6	27	14	18	25	630	9137	S
AME08SMG04.1	16X1,5	1/4"	8	19	12	15	22	630	9137	S
AME08SMG06.1	16X1,5	3/8"	8	22	12	15,5	22,5	630	9137	S
AME10SMG04.1	18X1,5	1/4"	10	19	12	14,5	22	630	9137	S
AME10SMG06.1	18X1,5	3/8"	10	22	12	15	22,5	630	9137	S
AME10SMG08.1	18X1,5	1/2"	10	27	14	17,5	25	630	9137	S
AME12SMG04.1	20X1,5	1/4"	12	22	12	16,5	24	630	9137	S
AME12SMG06.1	20X1,5	3/8"	12	22	12	17	24,5	630	9137	S
AME12SMG08.1	20X1,5	1/2"	12	27	14	17,5	25	630	9137	S
AME14SMG06.1	22X1,5	3/8"	14	24	12	18,5	26,5	630	9137	S
AME14SMG08.1	22X1,5	1/2"	14	27	14	19	27	630	9137	S
AME16SMG06.1	24X1,5	3/8"	16	27	12	18	26,5	400	5801	S
AME16SMG08.1	24X1,5	1/2"	16	27	14	18,5	27	400	5801	S
AME16SMG12.1	24X1,5	3/4"	16	32	16	20,5	29	400	5801	S

DIN MALE STUD COUPLING - BSPP MALE FORM B (3)

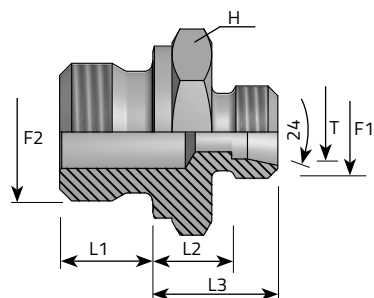

ADATTATORE DIRITTO M. DIN - M.GAS CILINDRICO FORMA B DIN 3852
UNION SIMPLE MÂLE BSPP FORME B DIN 3852
 GERADE EINSCHRAUBVERSCHRAUBUNG FORM B
 DIN 3852 – METRISCH 24° / AGR-Z
RACOR RECTO BSPP FORMA B DIN 3852

F1 Metrisch, Metrico, Metric, Métrique, Métrico

F2 Zylinder-Gasgewinde, Gas cilíndrico, BSPP, Gaz cylindrique,
 Gas cilíndrica

Code	Thread		Dimensions					Pressure		Series
	F1	F2	T	H	L1	L2	L3	Bar	Psi	
			mm	mm	mm	mm	mm			
AME20SMG08.1	30X2	1/2"	20	32	14	20,5	26	400	5801	S
AME20SMG12.1	30X2	3/4"	20	32	16	20,5	32	400	5801	S
AME20SMG16.1	30x2	1"	20	41	18	22,5	39	400	5801	S
AME25SMG12.1	36X2	3/4"	25	41	16	23	32	400	5801	S
AME25SMG16.1	36X2	1"	25	41	18	23	39	400	5801	S
AME30SMG16.1	42X2	1"	30	46	18	23,5	39	400	5801	S
AME30SMG20.1	42x2	1,1/4"	30	50	20	23,5	39	400	5801	S
AME38SMG20.1	52X2	1.1/4"	38	55	20	26	49	315	4568	S
AME38SMG24.1	52X2	1.1/2"	38	55	22	26	55	315	4568	S

DIN MALE STUD COUPLING - BSPP MALE FORM E (1)

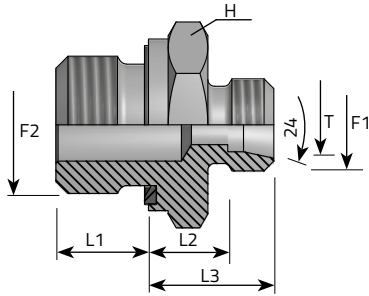

ADATTATORE DIRITTO M- DIN -M.GAS CILINDRICO FORMA E DIN 3852
 UNION SIMPLE MÂLE AVEC JOINT EN CAOUTCHOUC BSPP FORME E
 GERADE EINSCHRAUBVERSCHRAUBUNG MIT GUMMIDICHTUNG FORM E
 DIN 3852 – METRISCH 24° / AGR-Z
 RACOR RECTO CON JUNTA TÓRICA BSPP FORMA E DIN 3852

F1 Metrisch, Metrico, Metric, Métrique, Métrico

F2 Zylinder-Gasgewinde, Gas cilíndrico, BSPP, Gaz cylindrique,
 Gas cilíndrica

Code	Thread		Dimensions					Pressure		Series
	F1	F2	T	H	L1	L2	L3	Bar	Psi	
			mm	mm	mm	mm	mm			
AME06LMG02EL.1	12x1,5	1/8"	6	14	8	8,5	15,5	315	4568	L
AME06LMG04EL.1	12x1,5	1/4"	6	19	12	10	17	315	4568	L
AME06LMG06EL.1	12x1,5	3/8"	6	22	12	11,5	18,5	315	4568	L
AME08LMG02EL.1	14x1,5	1/8"	8	14	8	9,5	16,5	315	4568	L
AME08LMG04EL.1	14x1,5	1/4"	8	19	12	10	17	315	4568	L
AME08LMG06EL.1	14x1,5	3/8"	8	22	12	11,5	18,5	315	4568	L
AME08LMG08EL.1	14x1,5	1/2"	8	27	14	12	19	315	4568	L
AME10LMG02EL.1	16x1,5	1/8"	10	17	8	11	18	315	4568	L
AME10LMG04EL.1	16x1,5	1/4"	10	19	12	11	18	315	4568	L
AME10LMG06EL.1	16x1,5	3/8"	10	22	12	12,5	19,5	315	4568	L
AME10LMG08EL.1	16x1,5	1/2"	10	27	14	13	20	315	4568	L
AME12LMG04EL.1	18x1,5	1/4"	12	19	12	12	19	315	4568	L
AME12LMG06EL.1	18x1,5	3/8"	12	22	12	12,5	19,5	315	4568	L
AME12LMG08EL.1	18x1,5	1/2"	12	27	14	13	20	315	4568	L
AME15LMG06EL.1	22x1,5	3/8"	15	24	12	13,5	20,5	315	4568	L
AME15LMG08EL.1	22x1,5	1/2"	15	27	14	14	21	315	4568	L
AME15LMG12EL.1	22x1,5	3/4"	15	32	16	15	22	315	4568	L
AME18LMG08EL.1	26x1,5	1/2"	18	27	14	14,5	22	315	4568	L
AME18LMG12EL.1	26x1,5	3/4"	18	32	16	14,5	22	315	4568	L
AME22LMG08EL.1	30x2	1/2"	22	32	14	16,5	24	160	2320	L
AME22LMG12EL.1	30x2	3/4"	22	32	16	16,5	24	160	2320	L
AME22LMG16EL.1	30x2	1"	22	41	18	17,5	25	160	2320	L

DIN MALE STUD COUPLING - BSPP MALE FORM E (2)

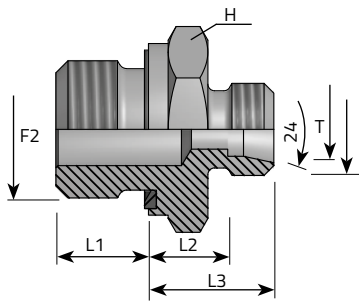

ADATTATORE DIRITTO M- DIN -M.GAS CILINDRICO FORMA E DIN 3852
 UNION SIMPLE MÂLE AVEC JOINT EN CAOUTCHOUC BSPP FORME E
 GERADE EINSCHRAUBVERSCHRAUBUNG MIT GUMMIDICHTUNG FORM E
 DIN 3852 – METRISCH 24° / AGR-Z
 RACOR RECTO CON JUNTA TÓRICA BSPP FORMA E DIN 3852

- F1 Metrisch, Metrico, Metric, Métrique, Métrico
 F2 Zylinder-Gasgewinde, Gas cilíndrico, BSPP, Gaz cylindrique,
 Gas cilíndrica

Code	Thread		Dimensions					Pressure		Series
	F1	F2	T	H	L1	L2	L3	Bar	Psi	
			mm	mm	mm	mm	mm			
AME28LMG12EL.1	36x2	3/4"	28	41	16	17,5	25	160	2320	L
AME28LMG16EL.1	36x2	1"	28	41	18	17,5	25	160	2320	L
AME35LMG16EL.1	45x2	1"	35	46	18	17,5	28	160	2320	L
AME35LMG20EL.1	45x2	1.1/4"	35	50	20	17,5	28	160	2320	L
AME42LMG24EL.1	52x2	1.1/2"	42	55	22	19	30	160	2320	L
AME06SMG04EL.1	14x1,5	1/4"	6	19	12	13	20	630	9137	S
AME08SMG04EL.1	16x1,5	1/4"	8	19	12	15	22	630	9137	S
AME08SMG06EL.1	16x1,5	3/8"	8	22	12	15,5	22,5	630	9137	S
AME10SMG04EL.1	18x1,5	1/4"	10	19	12	14,5	22	630	9137	S
AME10SMG06EL.1	18x1,5	3/8"	10	22	12	15	22,5	630	9137	S
AME10SMG08EL.1	18x1,5	1/2"	10	27	14	17,5	25	630	9137	S
AME12SMG04EL.1	20x1,5	1/4"	12	22	12	16,5	24	630	9137	S
AME12SMG06EL.1	20x1,5	3/8"	12	22	12	17	24,5	630	9137	S
AME12SMG08EL.1	20x1,5	1/2"	12	27	14	17,5	25	630	9137	S
AME14SMG06EL.1	22x1,5	3/8"	14	24	12	18,5	26,5	630	9137	S
AME14SMG08EL.1	22x1,5	1/2"	14	27	14	19	27	630	9137	S
AME16SMG06EL.1	24x1,5	3/8"	16	27	12	18	26,5	400	5801	S
AME16SMG08EL.1	24x1,5	1/2"	16	27	14	18,5	27	400	5801	S
AME16SMG12EL.1	24x1,5	3/4"	16	32	16	20,5	29	400	5801	S
AME20SMG08EL.1	30x2	1/2"	20	32	14	20,5	31	400	5801	S
AME20SMG12EL.1	30x2	3/4"	20	32	16	20,5	31	400	5801	S
AME20SMG16EL.1	30x2	1"	20	41	18	22,5	34,5	400	5801	S

DIN MALE STUD COUPLING - BSPP MALE FORM E (3)

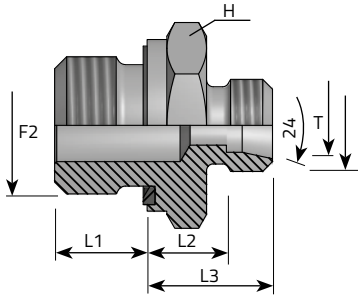

ADATTATORE DIRITTO M- DIN -M.GAS CILINDRICO FORMA E DIN 3852
 UNION SIMPLE MÂLE AVEC JOINT EN CAOUTCHOUC BSPP FORME E
 GERADE EINSCHRAUBVERSCHRAUBUNG MIT GUMMIDICHTUNG FORM E
 DIN 3852 – METRISCH 24° / AGR-Z
 RACOR RECTO CON JUNTA TÔRICA BSPP FORMA E DIN 3852

F1 Metrisch, Metrico, Metric, Métrique, Métrico

F2 Zylinder-Gasgewinde, Gas cilindrigo, BSPP, Gaz cylindrique,
 Gas cilindrigo

Code	Thread		Dimensions					Pressure		Series
	F1	F2	T	H	L1	L2	L3	Bar	Psi	
			mm	mm	mm	mm	mm			
AME25SMG12EL.1	36x2	3/4"	25	41	16	23	35	400	5801	S
AME25SMG16EL.1	36x2	1"	25	41	18	23	35	400	5801	S
AME30SMG16EL.1	42x2	1"	30	46	18	23,5	37	400	5801	S
AME30SMG20EL.1	42x2	1.1/4"	30	50	20	23,5	37	400	5801	S
AME38SMG20EL.1	52x2	1.1/4"	38	50	20	26	42	315	4568	S
AME38SMG24EL.1	52x2	1.1/2"	38	55	22	26	42	315	4568	S

DIN MALE STUD COUPLING SV 60° - BSPP MALE (1)

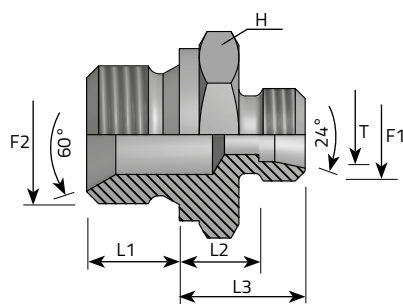

ADATTATORE DIRITTO M. DIN - M. GAS CILINDRICO SV 60°
UNION SIMPLE MÂLE BSPP SV 60°
 GERADE EINSCHRAUBVERSCHRAUBUNG SV 60° – METRISCH 24° / BSP
 60° (AGR)
RACOR RECTO BSPP

F1 Metrisch, Metrico, Metric, Métrique, Métrico

F2 Zylinder-Gasgewinde, Gas cilindrico, BSPP, Gaz cylindrique,
 Gas cilíndrica

Code	Thread		Dimensions					Pressure		Series
	F1	F2	T	H	L1	L2	L3	Bar	Psi	L/S
			mm	mm	mm	mm	mm			
AME06LMG02SV.1	12X1,5	1/8"	6	14	8	8,5	15,5	315	4568	L
AME06LMG04SV.1	12X1,5	1/4"	6	19	12	10	17	315	4568	L
AME06LMG06SV.1	12X1,5	3/8"	6	22	12	11,5	18,5	315	4568	L
AME06LMG08SV.1	12X1,5	1/2"	6	27	14	12	19	315	4568	L
AME08LMG02SV.1	14X1,5	1/8"	8	14	8	8,5	15,5	315	4568	L
AME08LMG04SV.1	14X1,5	1/4"	8	19	12	10	17	315	4568	L
AME08LMG06SV.1	14X1,5	3/8"	8	22	12	11,5	18,5	315	4568	L
AME08LMG08SV.1	14X1,5	1/2"	8	27	14	12	19	315	4568	L
AME10LMG02SV.1	16X1,5	1/8"	10	17	8	10,5	17,5	315	4568	L
AME10LMG04SV.1	16X1,5	1/4"	10	19	12	11	18	315	4568	L
AME10LMG06SV.1	16X1,5	3/8"	10	22	12	12,5	19,5	315	4568	L
AME10LMG08SV.1	16X1,5	1/2"	10	27	14	13	20	315	4568	L
AME12LMG04SV.1	18X1,5	1/4"	12	19	12	12	19	315	4568	L
AME12LMG06SV.1	18X1,5	3/8"	12	22	12	12,5	19,5	315	4568	L
AME12LMG08SV.1	18X1,5	1/2"	12	27	14	13	20	315	4568	L
AME12LMG12SV.1	18X1,5	3/4"	12	32	16	14	21	315	4568	L
AME15LMG06SV.1	22X1,5	3/8"	15	24	12	13,5	20,5	315	4568	L
AME15LMG08SV.1	22X1,5	1/2"	15	27	14	14	21	315	4568	L
AME15LMG12SV.1	22X1,5	3/4"	15	32	16	15	22	315	4568	L
AME18LMG06SV.1	26X1,5	3/8"	18	27	12	14	21,5	315	4568	L
AME18LMG08SV.1	26X1,5	1/2"	18	27	14	14,5	22	315	4568	L
AME18LMG12SV.1	26X1,5	3/4"	18	32	16	14,5	22	315	4568	L

DIN MALE STUD COUPLING SV 60° - BSPP MALE (2)

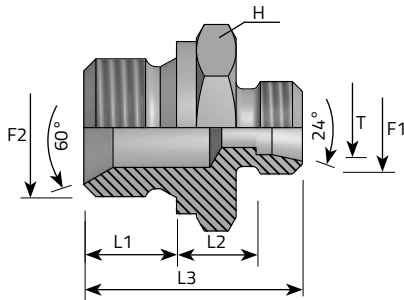

ADATTATORE DIRITTO M. DIN - M. GAS CILINDRICO SV 60°
 UNION SIMPLE MÂLE BSPP SV 60°
 GERADE EINSCHRAUBVERSCHRAUBUNG SV 60° – METRISCH 24°/BSP
 60° (AGR)
 RACOR RECTO BSPP

- F1 Metrisch, Metrico, Metric, Métrique, Métrico
 F2 Zylinder-Gasgewinde, Gas cilíndrico, BSPP, Gaz cylíndrique,
 Gas cilíndrica

Code	Thread		Dimensions					Pressure		Series
	F1	F2	T	H	L1	L2	L3	Bar	Psi	
			mm	mm	mm	mm	mm			
AME22LMG08SV.1	30X2	1/2"	22	32	14	16,5	24	160	2320	L
AME22LMG12SV.1	30X2	3/4"	22	32	16	16,5	24	160	2320	L
AME22LMG16SV.1	30X2	1"	22	41	18	17,5	25	160	2320	L
AME28LMG12SV.1	36X2	3/4"	28	41	16	17,5	25	160	2320	L
AME28LMG16SV.1	36X2	1"	28	41	18	17,5	25	160	2320	L
AME35LMG16SV.1	45X2	1"	35	46	18	17,5	28	160	2320	L
AME35LMG20SV.1	45X2	1.1/4"	35	50	20	17,5	28	160	2320	L
AME42LMG20SV.1	52x2	1.1/4"	42	55	20	19	30	160	2320	L
AME42LMG24SV.1	52X2	1.1/2"	42	55	22	19	30	160	2320	L
AME06SMG04SV.1	14X1,5	1/4"	6	19	12	13	20	630	9137	S
AME06SMG08SV.1	14X1,5	1/2"	6	27	14	18	25	630	9137	S
AME08SMG04SV.1	16X1,5	1/4"	8	19	12	15	22	630	9137	S
AME08SMG06SV.1	16X1,5	3/8"	8	22	12	15,5	22,5	630	9137	S
AME10SMG04SV.1	18X1,5	1/4"	10	19	12	14,5	22	630	9137	S
AME10SMG06SV.1	18X1,5	3/8"	10	22	12	15	22,5	630	9137	S
AME10SMG08SV.1	18X1,5	1/2"	10	27	14	17,5	25	630	9137	S
AME12SMG04SV.1	20X1,5	1/4"	12	22	12	16,5	24	630	9137	S
AME12SMG06SV.1	20X1,5	3/8"	12	22	12	17	24,5	630	9137	S
AME12SMG08SV.1	20X1,5	1/2"	12	27	14	17,5	25	630	9137	S
AME14SMG06SV.1	22X1,5	3/8"	14	24	12	18,5	26,5	630	9137	S
AME14SMG08SV.1	22X1,5	1/2"	14	27	14	19	27	630	9137	S
AME16SMG06SV.1	24X1,5	3/8"	16	27	12	18	26,5	400	5801	S

DIN MALE STUD COUPLING SV 60° - BSPP MALE (3)

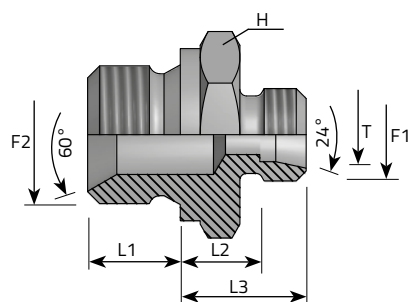

ADATTATORE DIRITTO M. DIN - M. GAS CILINDRICO SV 60°
UNION SIMPLE MÂLE BSPP SV 60°
 GERADE EINSCHRAUBVERSCHRAUBUNG SV 60° – METRISCH 24° / BSP
 60° (AGR)
RACOR RECTO BSPP

F1 Metrisch, Metrico, Metric, Métrique, Métrico

F2 Zylinder-Gasgewinde, Gas cilindrico, BSPP, Gaz cylindrique,
 Gas cilíndrica

Code	Thread		Dimensions					Pressure		Series
	F1	F2	T	H	L1	L2	L3	Bar	Psi	
			mm	mm	mm	mm	mm			
AME16SMG08SV.1	24X1,5	1/2"	16	27	14	18,5	27	400	5801	S
AME16SMG12SV.1	24X1,5	3/4"	16	32	16	20,5	29	400	5801	S
AME20SMG08SV.1	30X2	1/2"	20	32	14	20,5	31	400	5801	S
AME20SMG12SV.1	30X2	3/4"	20	32	16	20,5	31	400	5801	S
AME20SMG16SV.1	30x2	1"	20	41	18	22,5	33	400	5801	S
AME25SMG12SV.1	36X2	3/4"	25	41	16	23	35	400	5801	S
AME25SMG16SV.1	36X2	1"	25	41	18	23	35	400	5801	S
AME30SMG16SV.1	42X2	1"	30	46	18	23,5	37	400	5801	S
AME30SMG20SV.1	42x2	1,1/4"	30	50	20	23,5	37	400	5801	S
AME38SMG20SV.1	52X2	1.1/4"	38	55	20	26	42	315	4568	S
AME38SMG24SV.1	52X2	1.1/2"	38	55	22	26	42	315	4568	S

DIN MALE BULKHEAD CONNECTION - BSPP MALE FORM E

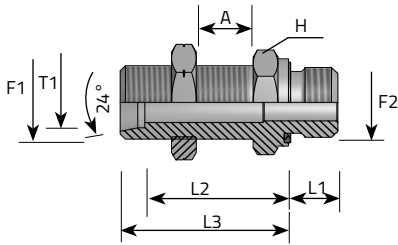

PASSAPARETE DIRITTO M DIN - M GAS CILINDRICO FORMA E
 UNION DOUBLE – TRAVERSÉE DE CLOISON BSPP FORME E
 GERADE SCHOTTVERSCHRAUBUNG FORM E – METRISCH 24° / AGR-Z
 RACOR RECTO PASATABIQUE BSPP FORMA E

F1 Metrisch, Metrico, Metric, Métrique, Métrico

F2 Zylinder-Gasgewinde, Gas cilíndrico, BSPP, Gaz cylíndrique,
 Gas cilíndrica

Code	Thread		Dimensions						Pressure		Series
	F1	F2	T1	H	A MAX	L1	L2	L3	Bar	Psi	
			mm	mm	mm	mm	mm				
APPME06LMG02EL.1	12x1,5	1/8"	6	17	16	8	32,5	39,5	315	4568	L
APPME08LMG04EL.1	14x1,5	1/4"	8	19	16	12	34	41	315	4568	L
APPME10LMG04EL.1	16x1,5	1/4"	10	22	16	12	36	43	315	4568	L
APPME12LMG06EL.1	18x1,5	3/8"	12	24	16	12	37,5	44,5	315	4568	L
APPME15LMG08EL.1	22x1,5	1/2"	15	27	16	14	41	48	315	4568	L
APPME18LMG08EL.1	26x1,5	1/2"	18	32	16	14	44,5	52	315	4568	L
APPME22LMG12EL.1	30x2	3/4"	22	36	16	16	47,5	55	160	2320	L
APPME28LMG16EL.1	36x2	1"	28	41	16	18	50,5	58	160	2320	L
APPME35LMG20EL.1	45x2	1.1/4"	35	50	16	20	52,5	63	160	2320	L
APPME42LMG24EL.1	52x2	1.1/2"	42	60	16	22	53	64	160	2320	L
APPME06SMG04EL.1	14x1,5	1/4"	6	19	16	12	38	45	630	9137	S
APPME08SMG04EL.1	16x1,5	1/4"	8	22	16	12	39	46	630	9137	S
APPME10SMG06EL.1	18x1,5	3/8"	10	24	16	12	41,5	49	630	9137	S
APPME12SMG06EL.1	20x1,5	3/8"	12	27	16	12	42,5	50	630	9137	S
APPME14SMG08EL.1	22x1,5	1/2"	14	30	16	14	46	54	630	9137	S
APPME16SMG08EL.1	24x1,5	1/2"	16	32	16	14	45,5	54	400	5801	S
APPME20SMG12EL.1	30x2	3/4"	20	41	16	16	48,5	59	400	5801	S
APPME25SMG16EL.1	36x2	1"	25	46	16	18	52	64	400	5801	S
APPME30SMG20EL.1	42x2	1.1/4"	30	50	16	20	55,5	69	400	5801	S
APPME38SMG24EL.1	52x2	1.1/2"	38	65	16	22	56	72	315	4568	S

DIN MALE STUD COUPLING - METRIC MALE FORM B (1)

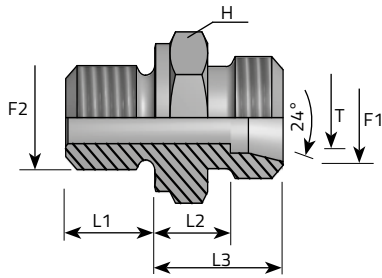

ADATTATORE DIRITTO M. DIN - M. METRICO FORMA B DIN 3852
UNION SIMPLE MÂLE BSPP FORME B
 GERADE EINSCHRAUBVERSCHRAUBUNG FORM B
 DIN 3852 – MÉTRISCH 24° / MÉTRISCH-ZYLINDRISCH
RACOR RECTO BSPP FORMA B

F1 Metrisch, Metrico, Metric, Métrique, Métrico

F2 Metrisch, Metrico, Metric, Métrique, Métrico

Code	Thread		Dimensions					Pressure		Series
	F1	F2	T	H	L1	L2	L3	Bar	Psi	L/S
			mm	mm	mm	mm	mm			
AME06LMM10.1	12x1,5	10x1	6	14	8	8,5	15,5	315	4568	L
AME08LMM12.1	14x1,5	12x1,5	8	17	12	10	17	315	4568	L
AME08LMM14.1	14x1,5	14x1,5	8	19	12	10	17	315	4568	L
AME08LMM16.1	14x1,5	16x1,5	8	22	12	11,5	18,5	315	4568	L
AME08LMM18.1	14x1,5	18x1,5	8	24	12	11,5	18,5	315	4568	L
AME10LMM14.1	16x1,5	14x1,5	10	19	12	11	18	315	4568	L
AME10LMM16.1	16x1,5	16x1,5	10	22	12	12	19	315	4568	L
AME10LMM18.1	16x1,5	18x1,5	10	24	12	12,5	19,5	315	4568	L
AME10LMM22.1	16x1,5	22x1,5	10	27	14	13	20	315	4568	L
AME12LMM14.1	18x1,5	14x1,5	12	19	12	11	18	315	4568	L
AME12LMM16.1	18x1,5	16x1,5	12	22	12	12,5	19,5	315	4568	L
AME12LMM18.1	18x1,5	18x1,5	12	24	12	12,5	19,5	315	4568	L
AME12LMM22.1	18x1,5	22x1,5	12	27	14	14	21	315	4568	L
AME15LMM16.1	22x1,5	16x1,5	15	24	12	13,5	20,5	315	4568	L
AME15LMM18.1	22x1,5	18x1,5	15	24	14	14	21	315	4568	L
AME15LMM22.1	22x1,5	22x1,5	15	27	14	15	22	315	4568	L
AME18LMM18.1	26x1,5	18x1,5	18	27	12	14	21,5	315	4568	L
AME18LMM22.1	26x1,5	22x1,5	18	27	14	14,5	22	315	4568	L
AME18LMM26.1	26x1,5	26x1,5	18	32	16	16,5	24	315	4568	L
AME22LMM22.1	30x2	22x1,5	22	32	14	16,5	24	160	2320	L
AME22LMM26.1	30x2	26x1,5	22	32	16	16,5	24	160	2320	L
AME28LMM33.1	36x2	33x2	28	41	18	17,5	25	160	2320	L

DIN MALE STUD COUPLING - METRIC MALE FORM B (2)

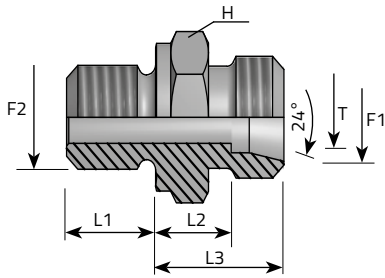

ADATTATORE DIRITTO M. DIN - M. METRICO FORMA B DIN 3852
 UNION SIMPLE MÂLE BSPP FORME B
 GERADE EINSCHRAUBVERSCHRAUBUNG FORM B
 DIN 3852 – METRISCH 24° / METRISCH-ZYLINDRISCH
 RACOR RECTO BSPP FORMA B

F1 Metrisch, Metrico, Metric, Métrique, Métrico

F2 Metrisch, Metrico, Metric, Métrique, Métrico

Code	Thread		Dimensions					Pressure		Series
	F1	F2	T	H	L1	L2	L3	Bar	Psi	
			mm	mm	mm	mm	mm			
AME35LMM42.1	45x2	42x2	35	50	20	17,5	27,5	160	2320	L
AME42LMM48.1	52x2	48x2	42	55	22	19	30	160	2320	L
AME06SMM12.1	14x1,5	12x1,5	6	17	12	13	20	630	9137	S
AME08SMM14.1	16x1,5	14x1,5	8	19	12	15	22	630	9137	S
AME10SMM16.1	18x1,5	16x1,5	10	22	12	15	22,5	630	9137	S
AME10SMM18.1	18x1,5	18x1,5	10	24	12	15,5	23	630	9137	S
AME12SMM18.1	20x1,5	18x1,5	12	24	12	17	24,5	630	9137	S
AME12SMM22.1	20x1,5	22x1,5	12	27	14	17,5	25	630	9137	S
AME14SMM20.1	22x1,5	20x1,5	14	27	14	19	27	630	9137	S
AME16SMM18.1	24x1,5	18x1,5	16	27	12	18	26,5	400	5801	S
AME16SMM22.1	24x1,5	22x1,5	16	27	14	18,5	27	400	5801	S
AME20SMM27.1	30x2	27x2	20	32	16	20,5	31	400	5801	S
AME25SMM27.1	36x2	27x2	25	41	16	23	35	400	5801	S
AME25SMM33.1	36x2	33x2	25	41	18	23	35	400	5801	S
AME30SMM42.1	42x2	42x2	30	50	20	23,5	37	400	5801	S
AME38SMM48.1	52x2	48x2	38	55	22	26	42	315	4568	S

DIN MALE STUD COUPLING - METRIC MALE FORM E (1)

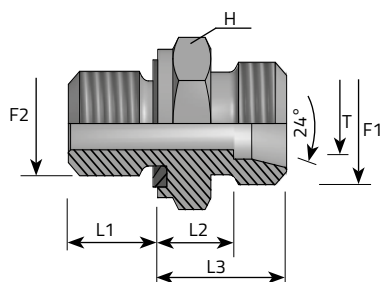

ADATTATORE DIRITTO MASCHIO DIN - M. METRICO FORMA E DIN 3852
 UNION SIMPLE MÂLE AVEC JOINT EN CAOUTCHOUC METRIC FORME E
 GERADE EINSCHRAUBVERSCHRAUBUNG MIT GUMMIDICHTUNG FORM E
 DIN 3852 – METRISCH 24° / METRISCH-ZYLINDRISCH
 RACOR RECTO METRICO FORMA E

F1 Metrisch, Metrico, Metric, Métrique, Métrico

F2 Metrisch, Metrico, Metric, Métrique, Métrico

Code	Thread		Dimensions					Pressure		Series
	F1	F2	T	H	L1	L2	L3	Bar	Psi	
			mm	mm	mm	mm	mm			
AME06LMM10EL.1	12x1,5	10x1	6	14	8	8,5	15,5	315	4568	L
AME08LMM12EL.1	14x1,5	12x1,5	8	17	12	10	17	315	4568	L
AME10LMM14EL.1	16x1,5	14x1,5	10	19	12	11	18	315	4568	L
AME10LMM16EL.1	16x1,5	16x1,5	10	22	12	12	19	315	4568	L
AME10LMM18EL.1	16x1,5	18x1,5	10	24	12	12,5	19,5	315	4568	L
AME10LMM22EL.1	16x1,5	22x1,5	10	27	14	13	20	315	4568	L
AME12LMM14EL.1	18x1,5	14x1,5	12	19	12	12	19	315	4568	L
AME12LMM16EL.1	18x1,5	16x1,5	12	22	12	12,5	19,5	315	4568	L
AME12LMM18EL.1	18x1,5	18x1,5	12	24	12	12,5	19,5	315	4568	L
AME12LMM22EL.1	18x1,5	22x1,5	12	27	14	13	20	315	4568	L
AME15LMM16EL.1	22x1,5	16x1,5	15	24	12	13,5	20,5	315	4568	L
AME15LMM18EL.1	22x1,5	18x1,5	15	24	14	14	21	315	4568	L
AME15LMM22EL.1	22x1,5	22x1,5	15	27	14	15	22	315	4568	L
AME18LMM18EL.1	26x1,5	18x1,5	18	27	12	12,5	20	315	4568	L
AME18LMM22EL.1	26x1,5	22x1,5	18	27	14	14,5	22	315	4568	L
AME22LMM22EL.1	30x2	22x1,5	22	32	14	16,5	24	160	2320	L
AME22LMM26EL.1	30x2	26x1,5	22	32	16	16,5	24	160	2320	L
AME28LMM33EL.1	36x2	33x2	28	41	18	17,5	25	160	2320	L
AME35LMM42EL.1	45x2	42x2	35	50	20	17,5	28	160	2320	L
AME42LMM48EL.1	52x2	48x2	42	55	22	19	30	160	2320	L

DIN MALE STUD COUPLING - METRIC MALE FORM E (2)

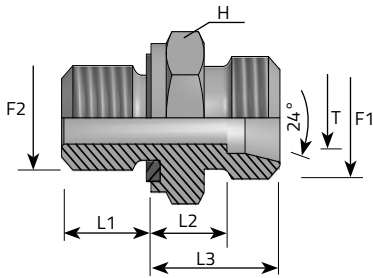

ADATTATORE DIRITTO MASCHIO DIN - M. METRICO FORMA E DIN 3852
 UNION SIMPLE MÂLE AVEC JOINT EN CAOUTCHOUC METRIC FORME E
 GERADE EINSCHRAUBVERSCHRAUBUNG MIT GUMMIDICHTUNG FORM E
 DIN 3852 – METRISCH 24° / METRISCH-ZYLINDRISCH
 RACOR RECTO METRICO FORMA E

F1 Metrisch, Metrico, Metric, Métrique, Métrico

F2 Metrisch, Metrico, Metric, Métrique, Métrico

Code	Thread		Dimensions					Pressure		Series
	F1	F2	T	H	L1	L2	L3	Bar	Psi	
			mm	mm	mm	mm	mm			
AME06SMM12EL.1	14x1,5	12x1,5	6	17	12	13	20	630	9137	S
AME08SMM14EL.1	16x1,5	14x1,5	8	19	12	15	22	630	9137	S
AME10SMM16EL.1	18X1,5	16X1,5	10	22	12	15	22,5	630	9137	S
AME12SMM18EL.1	20x1,5	18X1,5	12	24	12	17	24,5	630	9137	S
AME12SMM22EL.1	20x1,5	22X1,5	12	27	14	17,5	25	630	9137	S
AME14SMM20EL.1	22x1,5	20X1,5	14	27	14	19	27	630	9137	S
AME16SMM18EL.1	24x1,5	18X1,5	16	27	12	18	26	400	5801	S
AME16SMM22EL.1	24x1,5	22X1,5	16	27	14	18,5	27	400	5801	S
AME20SMM27EL.1	30x2	27X2	20	32	16	20,5	29	400	5801	S
AME25SMM33EL.1	36x2	33X2	25	41	18	23	33,5	400	5801	S
AME30SMM42EL.1	42x2	42X2	30	50	20	23,5	37	400	5801	S
AME38SMM48EL.1	52x2	48X2	38	55	22	26	42	315	4568	S

DIN MALE STUD COUPLING - UNF/UN MALE (1)

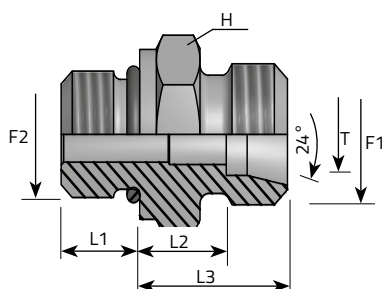

ADATTATORE DIRITTO MASCHIO DIN - MASCHIO UNF/UN
UNION SIMPLE MÂLE UNF
 GERADE EINSCHRAUBVERSCHRAUBUNG – METRISCH 24° / UNF-
 GEWINDE
RACOR RECTO UNF

F1 Metrisch, Metrico, Metric, Métrique, Métrico

F2 UNF

Code	Thread		Dimensions					Pressure		Series
	F1	F2	T	H	L1	L2	L3	Bar	Psi	L/S
			mm	mm	mm	mm	mm			
AME06LMU04.1	12X1,5	7/16"	6	14	9	10	17	315	4568	L
AME08LMU04.1	14X1,5	7/16"	8	17	9	10	17	315	4568	L
AME08LMU05.1	14X1,5	1/2"	8	17	9	10	17	315	4568	L
AME10LMU04.1	16X1,5	7/16"	10	17	9	11	18	315	4568	L
AME10LMU05.1	16X1,5	1/2"	10	17	9	11	18	315	4568	L
AME12LMU06.1	18X1,5	9/16"	12	19	10	11	18	315	4568	L
AME12LMU08.1	18X1,5	3/4"	12	24	11	13	20	315	4568	L
AME12LMU10.1	18X1,5	7/8"	12	27	12,7	14,3	21,3	315	4568	L
AME15LMU08.1	22X1,5	3/4"	15	24	11	14	21	315	4568	L
AME18LMU08.1	26X1,5	3/4"	18	27	11	14,5	22	315	4568	L
AME18LMU10.1	26X1,5	7/8"	18	27	12,7	14,8	22,3	315	4568	L
AME22LMU10.1	30X2	7/8"	22	32	12,7	16,8	24,3	160	2320	L
AME22LMU12.1	30X2	1.1/16"	22	32	15	16,5	24	160	2320	L
AME22LMU16.1	30X2	1.5/16"	22	41	15	17,5	25	160	2320	L
AME28LMU12.1	36X2	1.1/16"	28	41	15	17,5	25	160	2320	L
AME28LMU16.1	36X2	1.5/16"	28	41	15	17,5	25	160	2320	L
AME35LMU16.1	45X2	1.5/16"	35	46	15	17,5	28	160	2320	L
AME35LMU20.1	45X2	1.5/8"	35	50	15	17,5	28	160	2320	L
AME42LMU20.1	52X2	1.5/8"	42	55	15	19	30	160	2320	L
AME42LMU24.1	52X2	1.7/8"	42	55	15	19	30	160	2320	L

DIN MALE STUD COUPLING - UNF/UN MALE (2)

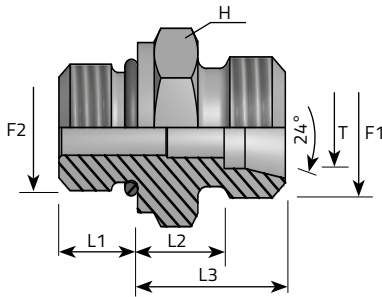

ADATTATORE DIRITTO MASCHIO DIN - MASCHIO UNF/UN
UNION SIMPLE MÂLE UNF
 GERADE EINSCHRAUBVERSCHRAUBUNG – METRISCH 24° / UNF-
 GEWINDE
RACOR RECTO UNF

F1 Metrisch, Metrico, Metric, Métrique, Métrico

F2 UNF

Code	Thread		Dimensions					Pressure		Series
	F1	F2	T	H	L1	L2	L3	Bar	Psi	
			mm	mm	mm	mm	mm			
AME06SMU05.1	14X1,5	1/2"	6	17	9	15	22	630	9137	S
AME08SMU04.1	16X1,5	7/16"	8	17	9	15	22	630	9137	S
AME08SMU05.1	16X1,5	1/2"	8	17	9	15	22	630	9137	S
AME10SMU06.1	18X1,5	9/16"	10	19	10	14,5	22	630	9137	S
AME12SMU06.1	20X1,5	9/16"	12	22	10	14,5	22	630	9137	S
AME12SMU08.1	20X1,5	3/4"	12	24	11	17,5	25	630	9137	S
AME14SMU08.1	22X1,5	3/4"	14	27	11	15,9	23,9	630	9137	S
AME16SMU08.1	24X1,5	3/4"	16	24	11	15,5	24	400	5801	S
AME16SMU10.1	24X1,5	7/8"	16	27	12,7	18,8	27,3	400	5801	S
AME20SMU08.1	30X2	3/4"	20	32	11	20,5	31	400	5801	S
AME20SMU10.1	30X2	7/8"	20	32	12,7	20,8	31,3	400	5801	S
AME20SMU12.1	30X2	1.1/16"	20	32	15	20,5	31	400	5801	S
AME25SMU12.1	36X2	1.1/16"	25	36	15	23	35	400	5801	S
AME25SMU16.1	36X2	1.5/16"	25	41	15	23	35	400	5801	S
AME30SMU16.1	42X2	1.5/16"	30	46	15	23,5	37	400	5801	S
AME30SMU20.1	42X2	1.5/8"	30	50	15	23,5	37	400	5801	S
AME38SMU20.1	52X2	1.5/8"	38	55	15	26	42	315	4568	S
AME38SMU24.1	52X2	1.7/8"	38	55	15	26	42	315	4568	S

DIN MALE STUD COUPLING - BSPT MALE (1)

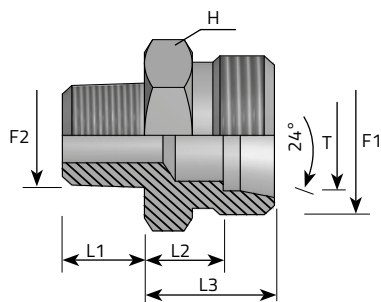

ADATTATORE DIRITTO MASCHIO DIN - MASCHIO GAS CONICO
UNION SIMPLE MÂLE BSPT
 GERADE EINSCHRAUBVERSCHRAUBUNG – METRISCH 24° / AGR-K
ROSCA CONICA BSPT

- F1 Metrisch, Metrico, Metric, Métrique, Métrico
 F2 Keglige-Gasgewinde, Gas conico, BSPT, Gaz conique, Rosca conica

Code	Thread		Dimensions					Pressure		Series
	F1	F2	T	H	L1	L2	L3	Bar	Psi	L/S
			mm	mm	mm	mm	mm			
AME06LMGK02.1	12x1,5	1/8"	6	12	10	7	14	315	4568	L
AME06LMGK04.1	12x1,5	1/4"	6	14	13	8	15	315	4568	L
AME08LMGK02.1	14x1,5	1/8"	8	14	10	8	15	315	4568	L
AME08LMGK04.1	14x1,5	1/4"	8	17	13	8	15	315	4568	L
AME08LMGK06.1	14x1,5	3/8"	8	19	13	9	16	315	4568	L
AME08LMGK08.1	14x1,5	1/2"	8	22	16	9	16	315	4568	L
AME10LMGK02.1	16x1,5	1/8"	10	17	10	9	16	315	4568	L
AME10LMGK04.1	16x1,5	1/4"	10	17	13	9	16	315	4568	L
AME10LMGK06.1	16x1,5	3/8"	10	19	13	10	17	315	4568	L
AME10LMGK08.1	16x1,5	1/2"	10	22	16	10	17	315	4568	L
AME12LMGK04.1	18x1,5	1/4"	12	19	13	10	17	315	4568	L
AME12LMGK06.1	18x1,5	3/8"	12	19	13	10	17	315	4568	L
AME12LMGK08.1	18x1,5	1/2"	12	22	16	10	17	315	4568	L
AME15LMGK06.1	22x1,5	3/8"	15	24	13	11	18	315	4568	L
AME15LMGK08.1	22x1,5	1/2"	15	24	16	11	18	315	4568	L
AME18LMGK06.1	26x1,5	3/8"	18	27	13	11,5	19	315	4568	L
AME18LMGK08.1	26x1,5	1/2"	18	27	16	11,5	19	315	4568	L
AME18LMGK12.1	26x1,5	3/4"	18	32	18	11,5	19	315	4568	L
AME22LMGK12.1	30x2	3/4"	22	32	18	13,5	21	160	2320	L
AME28LMGK16.1	36x2	1"	28	41	18	14,5	22	160	2320	L
AME35LMGK16.1	45x2	1"	35	46	18	14,5	25	160	2320	L

DIN MALE STUD COUPLING - BSPT MALE (2)

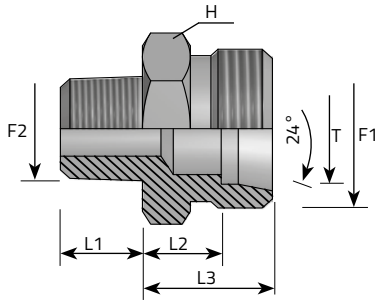

ADATTATORE DIRITTO MASCHIO DIN - MASCHIO GAS CONICO
UNION SIMPLE MÂLE BSPT
 GERADE EINSCHRAUBVERSCHRAUBUNG – METRISCH 24° / AGR-K
 ROSCA CONICA BSPT

- F1 Metrisch, Metrico, Metric, Métrique, Métrico
 F2 Keglige-Gasgewinde, Gas conico, BSPT, Gaz conique, Rosca conica

Code	Thread		Dimensions					Pressure		Series
	F1	F2	T	H	L1	L2	L3	Bar	Psi	
			mm	mm	mm	mm	mm			
AME35LMGK20.1	45x2	1.1/4"	35	46	21	14,5	25	160	2320	L
AME42LMGK24.1	52X2	1.1/2"	42	55	22	16	27	160	2320	L
AME06SMGK04.1	14X1,5	1/4"	6	17	13	12	19	630	9137	S
AME08SMGK04.1	16X1,5	1/4"	8	17	13	13	20	630	9137	S
AME10SMGK04.1	18X1,5	1/4"	10	19	13	12,5	20	630	9137	S
AME10SMGK06.1	18X1,5	3/8"	10	19	13	12,5	20	630	9137	S
AME12SMGK04.1	20X1,5	1/4"	12	22	13	14,5	22	630	9137	S
AME12SMGK06.1	20X1,5	3/8"	12	22	13	14,5	22	630	9137	S
AME12SMGK08.1	20X1,5	1/2"	12	22	16	14,5	22	630	9137	S
AME14SMGK06.1	22X1,5	3/8"	14	24	12	16	24	630	9137	S
AME14SMGK08.1	22X1,5	1/2"	14	24	16	16	24	630	9137	S
AME16SMGK06.1	24X1,5	3/8"	16	27	13	17,5	26	400	5801	S
AME16SMGK08.1	24X1,5	1/2"	16	27	16	17,5	26	400	5801	S
AME20SMGK08.1	30X2	1/2"	20	32	14	17,5	28	400	5801	S
AME20SMGK12.1	30X2	3/4"	20	32	18	17,5	28	400	5801	S
AME25SMGK12.1	36X2	3/4"	25	41	16	20	32	400	5801	S
AME25SMGK16.1	36X2	1"	25	41	18	18	30	400	5801	S
AME30SMGK16.1	42X2	1"	30	46	18	19,5	33	400	5801	S
AME30SMGK20.1	42X2	1.1/4"	30	46	21	19,5	33	400	5801	S
AME38SMGK20.1	52X2	1.1/4"	38	55	21	22	38	315	4568	S
AME38SMGK24.1	52X2	1.1/2"	38	55	22	22	38	315	4568	S

DIN MALE STUD COUPLING - NPT MALE (1)

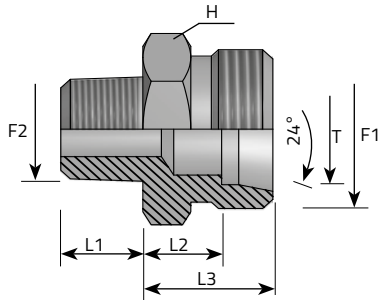

ADATTATORE DIRITTO MASCHIO DIN - MASCHIO NPT
 UNION SIMPLE MÂLE NPT
 GERADE EINSCHRAUBVERSCHRAUBUNG – METRISCH 24° / NPT
 RACOR RECTO NPT

F1 Metrisch, Metrico, Metric, Métrique, Métrico

F2 NPT

Code	Thread		Dimensions					Pressure		Series
	F1	F2	T	H	L1	L2	L3	Bar	Psi	L/S
			mm	mm	mm	mm	mm			
AME06LMN02.1	12x1,5	1/8"	6	12	10	7	14	315	4568	L
AME06LMN04.1	12x1,5	1/4"	6	14	15	8	15	315	4568	L
AME08LMN02.1	14x1,5	1/8"	8	14	10	8	15	315	4568	L
AME08LMN04.1	14x1,5	1/4"	8	17	15	8	15	315	4568	L
AME08LMN06.1	14x1,5	3/8"	8	19	15	9	16	315	4568	L
AME10LMN02.1	16x1,5	1/8"	10	17	10	9	16	315	4568	L
AME10LMN04.1	16x1,5	1/4"	10	17	15	9	16	315	4568	L
AME10LMN06.1	16x1,5	3/8"	10	19	15	10	17	315	4568	L
AME10LMN08.1	16x1,5	1/2"	10	22	20	10	17	315	4568	L
AME12LMN04.1	18x1,5	1/4"	12	19	15	10	17	315	4568	L
AME12LMN06.1	18x1,5	3/8"	12	19	15	10	17	315	4568	L
AME12LMN08.1	18x1,5	1/2"	12	22	20	10	17	315	4568	L
AME15LMN06.1	22x1,5	3/8"	15	24	15	11	18	315	4568	L
AME15LMN08.1	22x1,5	1/2"	15	24	20	10	17	315	4568	L
AME18LMN08.1	26x1,5	1/2"	18	27	20	11,5	19	315	4568	L
AME18LMN12.1	26x1,5	3/4"	18	32	20	11,5	19	160	2320	L
AME22LMN12.1	30x2	3/4"	22	32	20	13,5	21	160	2320	L
AME28LMN16.1	36x2	1"	28	41	25	14,5	22	160	2320	L
AME35LMN20.1	45x2	1.1/4"	35	46	26	14,5	25	160	2320	L
AME42LMN24.1	52x2	1.1/2"	42	55	26	16	27	630	9137	L

DIN MALE STUD COUPLING - NPT MALE (2)

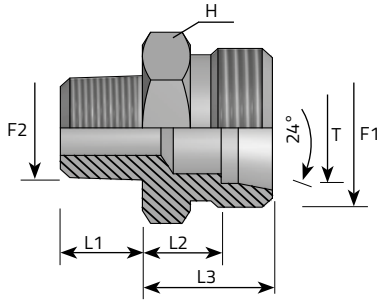

ADATTATORE DIRITTO MASCHIO DIN - MASCHIO NPT
 UNION SIMPLE MÂLE NPT
 GERADE EINSCHRAUBVERSCHRAUBUNG – METRISCH 24° / NPT
 RACOR RECTO NPT

F1 Metrisch, Metrico, Metric, Métrique, Métrico

F2 NPT

Code	Thread		Dimensions					Pressure		Series
	F1	F2	T	H	L1	L2	L3	Bar	Psi	
			mm	mm	mm	mm	mm			
AME06SMN04.1	14x1,5	1/4"	6	17	15	19	19	630	9137	S
AME08SMN04.1	16x1,5	1/4"	8	17	15	20	20	630	9137	S
AME10SMN04.1	18X1,5	1/4"	10	19	15	20	20	630	9137	S
AME10SMN06.1	18X1,5	3/8"	10	19	15	20	20	630	9137	S
AME12SMN04.1	20X1,5	1/4"	12	22	15	22	22	630	9137	S
AME12SMN06.1	20X1,5	3/8"	12	22	15	22	22	630	9137	S
AME12SMN08.1	20X1,5	1/2"	12	22	20	22	22	630	9137	S
AME14SMN06.1	22X1,5	3/8"	14	24	15	24	24	630	9137	S
AME14SMN08.1	22X1,5	1/2"	14	24	20	24	24	630	9137	S
AME16SMN06.1	24X1,5	3/8"	16	27	15	24	24	400	5801	S
AME16SMN08.1	24X1,5	1/2"	16	27	20	26	26	400	5801	S
AME20SMN08.1	30X2	1/2"	20	32	19,5	28,5	28.5	400	5801	S
AME20SMN12.1	30X2	3/4"	20	32	20	28	28	400	5801	S
AME25SMN12.1	36X2	3/4"	25	41	20	32	32	400	5801	S
AME25SMN16.1	36X2	1"	25	41	20	30	30	400	5801	S
AME30SMN16.1	42X2	1"	30	46	25	34	34	400	5801	S
AME30SMN20.1	42X2	1.1/4"	30	46	26	33	33	400	5801	S
AME38SMN24.1	52X2	1.1/2"	38	55	26	38	38	315	4568	S

DIN MALE STUD COUPLING - METRIC TAPER MALE

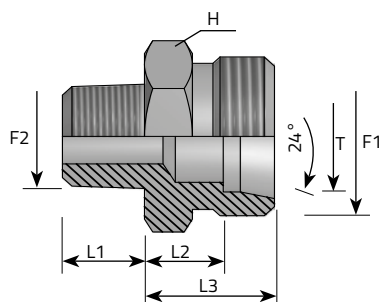

ADATTATORE DIRITTO MASCHIO DIN - MASCHIO METRICO CONICO
UNION SIMPLE MÂLE METRIC
 GERADE EINSCHRAUBVERSCHRAUBUNG – METRISCH 24° / METRISCH-KONISCH
RACOR RECTO METRICO

F1 Zylinder-Gasgewinde, Gas cilindrico, BSPP, Gaz cylindrique, Gas cilíndrica

F2 Kegeliges metrisches Gewinde, Metrico conico, Metric taper, Métrique conique, Métrico cónico

Code	Thread		Dimensions					Pressure		Series
	F1	F2	T	H	L1	L2	L3	Bar	Psi	
			mm	mm	mm	mm	mm			
AME06LMMK10.1	12X1,5	10X1	6	12	10	7	14	315	4568	L
AME08LMMK12.1	14X1,5	12X1,5	8	17	12	8	15	315	4568	L
AME10LMMK14.1	16X1,5	14X1,5	10	17	12	9	16	315	4568	L
AME12LMMK16.1	18X1,5	16X1,5	12	19	12	10	17	315	4568	L
AME15LMMK18.1	22X1,5	18X1,5	15	24	12	11	18	315	4568	L
AME18LMMK22.1	26X1,5	22X1,5	18	27	14	11,5	19	315	4568	L
AME22LMMK26.1	30X2	26X1,5	22	32	18	13,5	21	160	2320	L
AME28LMMK33.1	36X2	33X2	28	41	20	14,5	22	160	2320	L
AME35LMMK42.1	45X2	42X2	35	46	21	14,5	25	160	2320	L
AME42LMMK48.1	52X2	48X2	42	55	22	16	27	160	2320	L
AME06SMMK12.1	14X1,5	12X1,5	6	17	12	12	19	630	9137	S
AME08SMMK14.1	16X1,5	14X1,5	8	17	12	13	20	630	9137	S
AME10SMMK16.1	18X1,5	16X1,5	10	19	12	12,5	20	630	9137	S
AME12SMMK18.1	20X1,5	18X1,5	12	22	12	14,5	22	630	9137	S
AME14SMMK20.1	22X1,5	20X1,5	14	24	14	16	24	630	9137	S
AME16SMMK22.1	24X1,5	22X1,5	16	27	14	17,5	26	400	5801	S
AME20SMMK27.1	30X2	27X2	20	32	18	17,5	28	400	5801	S
AME25SMMK33.1	36X2	33X2	25	41	20	18	30	400	5801	S
AME30SMMK42.1	42X2	42X2	30	46	21	19,5	33	400	5801	S
AME38SMMK48.1	52X2	48X2	38	55	22	22	38	315	4568	S

DIN FEMALE STUD ADAPTER-BSPP MALE FORM E

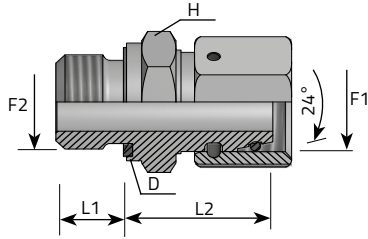

ADATTATORE F. GIREVOLE – M. GAS CILINDRICO FORMA E DIN 3852
 UNION SIMPLE M. D'ORIENTATION JOINT AVEC O-RING
 EINSTELLBARER GERADER EINSCHRAUBSTUTZEN MIT DICHTKEGEL UND
 O-RING
 RACOR RECTO CON JUNTA TÓRICA BSPP FORMA E

F1 Metrisch, Metrico, Metric, Métrique, Métrico

F2 Zylinder-Gasgewinde, Gas cilíndrico, BSPP, Gaz cylindrique,
 Gas cilíndrica

Code	Thread		Dimensions					Pressure		Series
	F1	F2	T	H	L1	L2	D	Bar	Psi	
			mm	mm	mm	mm	mm			
AFE06LMG02EL	12X1,5	1/8"	6	14	8	24,5	14	315	4568	L
AFE08LMG04EL	14X1,5	1/4"	8	19	12	29,5	19	315	4568	L
AFE10LMG04EL	16X1,5	1/4"	10	19	12	27,5	19	315	4568	L
AFE12LMG06EL	18X1,5	3/8"	12	22	12	34	22	315	4568	L
AFE15LMG08EL	22X1,5	1/2"	15	27	14	32	27	315	4568	L
AFE18LMG08EL	26X1,5	1/2"	18	27	14	31,5	27	315	4568	L
AFE22LMG12EL	30X2	3/4"	22	32	16	32,5	32	160	2320	L
AFE28LMG16EL	36X2	1"	28	41	18	35	40	160	2320	L
AFE35LMG20EL	45X2	1.1/4"	35	50	20	42,5	50	160	2320	L
AFE42LMG24EL	52X2	1.1/2"	42	55	22	46,5	55	160	2320	L
AFE06SMG04EL	14X1,5	1/4"	6	19	12	27	19	630	9137	S
AFE08SMG04EL	16X1,5	1/4"	8	19	12	29,5	19	630	9137	S
AFE10SMG06EL	18X1,5	3/8"	10	22	12	32	22	630	9137	S
AFE12SMG06EL	20X1,5	3/8"	12	22	12	34	22	630	9137	S
AFE14SMG08EL	22X1,5	1/2"	14	27	14	36,5	27	630	9137	S
AFE16SMG08EL	24X1,5	1/2"	16	27	14	37	27	400	5801	S
AFE20SMG12EL	30X2	3/4"	20	32	16	43	32	400	5801	S
AFE25SMG16EL	36X2	1"	25	41	18	48	40	400	5801	S
AFE30SMG20EL	42X2	1.1/4"	30	50	20	51	50	400	5801	S
AFE38SMG24EL	52X2	1.1/2"	38	55	22	60	55	315	4568	S

DIN FEMALE STUD ADPTER-METRIC FORM E

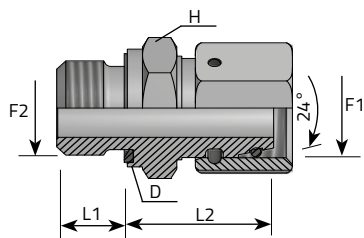

ADATTATORE FEMMINA GIREVOLE – MASCHIO METRICO FORMA E
 UNION SIMPLE MÂLE D'ORIENTATION JOINT AVEC O-RING
 FORME E EINSTELLBARER GERADER EINSCHRAUBSTUTZEN MIT
 DICHTKEGEL UND O-RING
 RACOR RECTO CON JUNTA TÔRICA BSPP FORMA E

F1 Metrisch, Metrico, Metric, Métrique, Métrico

F2 Metrisch, Metrico, Metric, Métrique, Métrico

Code	Thread		Dimensions					Pressure		Series
	F1	F2	T	H	L1	L2	D	Bar	Psi	
			mm	mm	mm	mm	mm			
AFE06LMM10EL	12X1,5	10x1	6	14	8	24,5	14	315	4568	L
AFE08LMM12EL	14X1,5	12x1,5	8	17	12	26,5	17	315	4568	L
AFE10LMM14EL	16X1,5	14x1,5	10	19	12	27,5	19	315	4568	L
AFE12LMM16EL	18X1,5	16x1,5	12	22	12	30,5	22	315	4568	L
AFE15LMM18EL	22X1,5	18x1,5	15	24	12	31,5	24	315	4568	L
AFE18LMM22EL	26X1,5	22x1,5	18	27	14	31,5	27	315	4568	L
AFE22LMM26EL	30X2	26x1,5	22	32	16	32,5	32	160	2320	L
AFE28LMM33EL	36X2	33x2	28	41	18	35	40	160	2320	L
AFE35LMM42EL	45X2	42x2	35	50	20	42,5	50	160	2320	L
AFE42LMM48EL	52X2	48x2	42	55	22	46,5	55	160	2320	L
AFE06SMM12EL	14X1,5	12x1,5	6	17	12	27	17	630	9137	S
AFE08SMM14EL	16X1,5	14x1,5	8	19	12	29,5	19	630	9137	S
AFE10SMM16EL	18X1,5	16x1,5	10	22	12	32	22	630	9137	S
AFE12SMM18EL	20X1,5	18x1,5	12	24	12	34	24	630	9137	S
AFE14SMM20EL	22X1,5	20x1,5	14	27	14	36,5	26	630	9137	S
AFE16SMM22EL	24X1,5	22x1,5	16	27	14	37	27	400	5801	S
AFE20SMM27EL	30X2	27x2	20	32	16	43	32	400	5801	S
AFE25SMM33EL	36X2	33x2	25	41	18	48	40	400	5801	S
AFE30SMM42EL	42X2	42x2	30	50	20	51	50	400	5801	S
AFE38SMM48EL	52X2	48x2	38	55	22	60	55	315	4568	S

DIN FEMALE STUD ADAPTER-NPT MALE

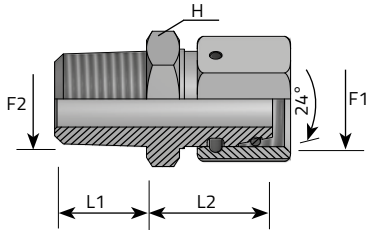

ADATTATORE DIRITTO FEMMINA GIREVOLE – MASCHIO NPT
 UNION SIMPLE MALE D'ORIENTATION AVEC O-RING/NPT
 EINSCHRAUBSTUTZEN MIT O-RING – DKOL 24° / NPT
 RACOR RECTO CON O-RING/NPT

F1 Metrisch, Metrico, Metric, Métrique, Métrico

F2 NPT

Code	Thread		Dimensions				Pressure		Series
	F1	F2	T	H	L1	L2	Bar	Psi	
			mm	mm	mm	mm			L/S
AFE06LMN02	12X1,5	1/8"	6	12	10	23	315	4568	L
AFE08LMN04	14X1,5	1/4"	8	14	15	27,5	315	4568	L
AFE10LMN04	16X1,5	1/4"	10	14	15	25,5	315	4568	L
AFE12LMN06	18X1,5	3/8"	12	19	15	31,5	315	4568	L
AFE15LMN08	22X1,5	1/2"	15	22	19,5	29	315	4568	L
AFE18LMN08	26X1,5	1/2"	18	24	19,5	28,5	315	4568	L
AFE22LMN12	30X2	3/4"	22	27	20	29,5	160	2320	L
AFE28LMN16	36X2	1"	28	36	25	32	160	2320	L
AFE35LMN20	45X2	1.1/4"	35	46	25,5	39,5	160	2320	L
AFE42LMN24	52X2	1.1/2"	42	50	26	43,5	160	2320	L
AFE06SMN04	14X1,5	1/4"	6	14	15	25	630	9137	S
AFE08SMN04	16X1,5	1/4"	8	14	15	27,5	630	9137	S
AFE10SMN06	18X1,5	3/8"	10	19	15	29,5	630	9137	S
AFE12SMN06	20X1,5	3/8"	12	19	15	31,5	630	9137	S
AFE14SMN08	22X1,5	1/2"	14	22	19,5	33,5	630	9137	S
AFE16SMN08	24X1,5	1/2"	16	22	19,5	34	400	5801	S
AFE20SMN12	30X2	3/4"	20	27	20	40	400	5801	S
AFE25SMN16	36X2	1"	25	36	25	45	400	5801	S
AFE30SMN20	42X2	1.1/4"	30	46	25,5	48	400	5801	S
AFE38SMN24	52X2	1.1/2"	38	50	26	57	315	4568	S

DIN FEMALE STUD ADAPTER-UNF MALE

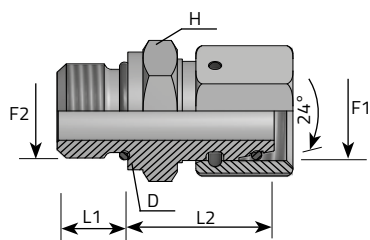

ADATTATORE DIRITTO FEMMINA GIREVOLE – MASCHIO UNF
 UNION SIMPLE MALE D'ORIENTATION AVEC O-RING/UNF
 GERADER AUFSTECKSTUTZEN MIT O-RING – DKOL 24° / UNF-Z
 RACOR RECTO CON O-RING/UNF

F1 Metrisch, Metrico, Metric, Métrique, Métrico

F2 UNF

Code	Thread		Dimensions					Pressure		Series
	F1	F2	T	H	L1	L2	D	Bar	Psi	
			mm	mm	mm	mm	mm			
AFE06LMU04	12X1,5	7/16"	6	14	8	23,4	13,8	315	4568	L
AFE08LMU04	14X1,5	7/16"	8	14	12	32,4	13,8	315	4568	L
AFE10LMU06	16X1,5	9/16"	10	17	12	29,5	18,8	315	4568	L
AFE12LMU08	18X1,5	3/4"	12	22	12	34,9	21,8	315	4568	L
AFE15LMU10	22X1,5	7/8"	15	27	14	33,3	26,8	315	4568	L
AFE18LMU10	26X1,5	7/8"	18	27	14	32,8	26,8	315	4568	L
AFE22LMU12	30X2	1.1/16"	22	32	16	33,4	31,8	160	2320	L
AFE28LMU16	36X2	1.5/16"	28	41	18	37,9	40,8	160	2320	L
AFE35LMU20	45X2	1.5/8"	35	50	20	47,4	49,8	160	2320	L
AFE42LMU24	52X2	1.7/8"	42	55	22	53,4	54,8	160	2320	L
AFE06SMU04	14X1,5	7/16"	6	14	12	29,9	13,8	630	9137	S
AFE08SMU06	16X1,5	9/16"	8	17	12	31,5	18,8	630	9137	S
AFE10SMU06	18X1,5	9/16"	10	17	12	34	18,8	630	9137	S
AFE12SMU08	20X1,5	3/4"	12	22	12	34,9	21,8	630	9137	S
AFE14SMU10	22X1,5	7/8"	14	27	14	37,8	26,8	630	9137	S
AFE16SMU10	24X1,5	7/8"	16	27	14	38,3	26,8	400	5801	S
AFE20SMU12	30X2	1.1/16"	20	32	16	43,9	31,8	400	5801	S
AFE25SMU16	36X2	1.5/16"	25	41	18	50,9	40,8	400	5801	S
AFE30SMU20	42X2	1.5/8"	30	50	20	55,9	49,8	400	5801	S
AFE38SMU24	52X2	1.7/8"	38	55	22	66,9	54,8	315	4568	S

BSPP MALE-DIN STUD STANDPIPE FORM B

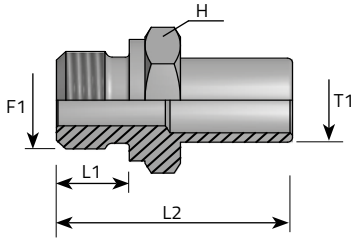

ADATTATORE DIRITTO MASCHIO GAS CILINDRICO FORMA B DIN 3852 – TUBO DIN
UNION SIMPLE MÂLE D'ORIENTATION FORME B DIN 385
 GERADER AUFSTECKSTUTZEN FORM B DIN 3852 – AGR-Z / BEL-BES
 RACOR TUBO ROSCADO CON TUERCA Y ANILLO FORMA B DIN 3852

F1 Zylinder-Gasgewinde, Gas cilíndrico, BSPP, Gaz cylindrique,

Gas cilíndrica

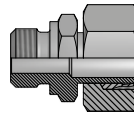

*Note: AMG02TL06.1 for body only
 AMG02TL06 for nut and cutting ring included*

Code	Thread	Dimensions				Pressure		Series
		T1	H	L1	L2	Bar	Psi	
	F1	mm	mm	mm	mm			
AMG02TL06.1	1/8"	6	14	8	32,5	315	4568	L
AMG04TL08.1	1/4"	8	19	12	41,5	315	4568	L
AMG04TL10.1	1/4"	10	19	12	39,5	315	4568	L
AMG06TL12.1	3/8"	12	22	12	46	315	4568	L
AMG08TL15.1	1/2"	15	27	14	46	315	4568	L
AMG08TL18.1	1/2"	18	27	14	45,5	315	4568	L
AMG12TL22.1	3/4"	22	32	16	48,5	160	2320	L
AMG16TL28.1	1"	28	41	18	53	160	2320	L
AMG20TL35.1	1.1/4"	35	50	20	62,5	160	2320	L
AMG24TL42.1	1.1/2"	42	55	22	68,5	160	2320	L
AMG04TS06.1	1/4"	6	19	12	39	630	9137	S
AMG04TS08.1	1/4"	8	19	12	41,5	630	9137	S
AMG06TS10.1	3/8"	10	22	12	44	630	9137	S
AMG06TS12.1	3/8"	12	22	12	46	630	9137	S
AMG08TS14.1	1/2"	14	27	14	50,5	630	9137	S
AMG08TS16.1	1/2"	16	27	14	51	400	5801	S
AMG12TS20.1	3/4"	20	32	16	59	400	5801	S
AMG16TS25.1	1"	2	41	18	66	400	5801	S
AMG20TS30.1	1.1/4"	30	50	20	71	400	5801	S
AMG24TS38.1	1.1/2"	38	55	22	82	315	4568	S

BSPP MALE-DIN STUD STANDPIPE FORM E

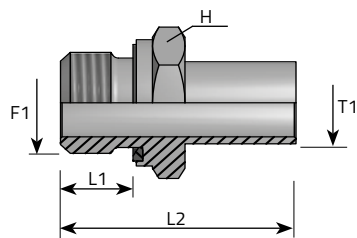

ADATTATORE DIRITTO MASCHIO GAS CILINDRICO FORMA E DIN 3852 –
TUBO DIN
UNION SIMPLE MÂLE D'ORIENTATION FORME E DIN 385
GERADER AUFSTECKSTUTZEN FORM E DIN 3852 – AGR-Z / BEL-BES
RACOR TUBO ROSCADO CON TUERCA Y ANILLO FORMA E DIN 3852

F1 Zylinder-Gasgewinde, Gas cilindrico, BSPP, Gaz cylindrique,
Gas cilindrica

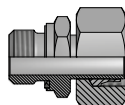

Note: AMG02ELTL06.1 for body only
AMG02ELTL06 for nut and cutting ring included

Code	Thread	Dimensions				Pressure		Series
		T1	H	L1	L2	Bar	Psi	
	F1	mm	mm	mm	mm			
AMG02ELTL06.1	1/8"	6	14	8	32,5	315	4568	L
AMG04ELTL08.1	1/4"	8	19	12	41,5	315	4568	L
AMG04ELTL10.1	1/4"	10	19	12	39,5	315	4568	L
AMG06ELTL12.1	3/8"	12	22	12	46	315	4568	L
AMG08ELTL15.1	1/2"	15	27	14	46	315	4568	L
AMG08ELTL18.1	1/2"	18	27	14	45,5	315	4568	L
AMG12ELTL22.1	3/4"	22	32	16	48,5	160	2320	L
AMG16ELTL28.1	1"	28	41	18	53	160	2320	L
AMG20ELTL35.1	1.1/4"	35	50	20	62,5	160	2320	L
AMG24ELTL42.1	1.1/2"	42	55	22	68,5	160	2320	L
AMG04ELTS06.1	1/4"	6	19	12	39	630	9137	S
AMG04ELTS08.1	1/4"	8	19	12	41,5	630	9137	S
AMG06ELTS10.1	3/8"	10	22	12	44,5	630	9137	S
AMG06ELTS12.1	3/8"	12	22	12	46	630	9137	S
AMG08ELTS14.1	1/2"	14	27	14	51	630	9137	S
AMG08ELTS16.1	1/2"	16	27	14	50,5	400	5801	S
AMG12ELTS20.1	3/4"	20	32	16	59	400	5801	S
AMG16ELTS25.1	1"	25	41	18	66	400	5801	S
AMG20ELTS30.1	1.1/4"	30	50	20	71	400	5801	S
AMG24ELTS38.1	1.1/2"	38	55	22	82	315	4568	S

METRIC MALE FORM B - DIN STUD STANDPIPE

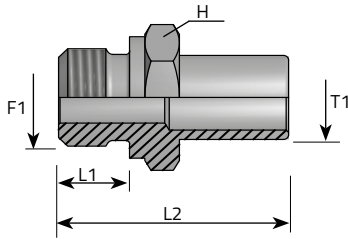

ADATTATORE DIRITTO MASCHIO GAS CILINDRICO FORMA B DIN 3852 – TUBO DIN
UNION SIMPLE MÂLE D'ORIENTATION FORME B DIN 385
 GERADER AUFSTECKSTUTZEN FORM B DIN 3852 – AGR-Z / BEL-BES
 RACOR TUBO ROSCADO CON TUERCA Y ANILLO FORMA B DIN 3852

F1 Metrisch, Metrico, Metric, Métrique, Métrico

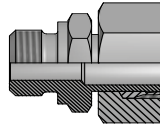

Note: AMM10TL06.1 for body only
 AMM10TL06 for nut and cutting ring included

Code	Thread	Dimensions				Pressure		Series
		F1	T1	H	L1	L2	Bar	
		mm	mm	mm	mm			
AMM10TL06.1	10X1	6	14	8	32,5	315	4568	L
AMM12TL08.1	12X1,5	8	17	12	38,5	315	4568	L
AMM14TL10.1	14X1,5	10	19	12	39,5	315	4568	L
AMM16TL12.1	16X1,5	12	22	12	46	315	4568	L
AMM18TL15.1	18X1,5	15	24	12	43,5	315	4568	L
AMM22TL18.1	22X1,5	18	27	14	45,5	315	4568	L
AMM26TL22.1	26X1,5	22	32	16	59	160	2320	L
AMM33TL28.1	33X2	28	41	18	53	160	2320	L
AMM42TL35.1	42X2	35	50	20	62,5	160	2320	L
AMM48TL42.1	48X2	42	55	22	68,5	160	2320	L
AMM12TS06.1	12X1,5	6	17	12	39	630	9137	S
AMM14TS08.1	14X1,5	8	19	12	41,5	630	9137	S
AMM16TS10.1	16X1,5	10	22	12	44	630	9137	S
AMM18TS12.1	18X1,5	12	24	12	46	630	9137	S
AMM20TS14.1	20X1,5	14	27	14	50,5	630	9137	S
AMM22TS16.1	22X1,5	16	27	14	51	400	5801	S
AMM27TS20.1	27X2	20	32	16	59	400	5801	S
AMM33TS25.1	33X2	25	41	18	66	400	5801	S
AMM42TS30.1	42X2	30	50	20	71	400	5801	S
AMM48TS38.1	48X2	38	55	22	82	315	4568	S

METRIC MALE FORM E - DIN STUD STANDPIPE

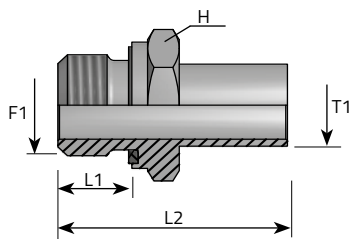

ADATTATORE DIRITTO MASCHIO METRICO FORMA E DIN 3852 – TUBO DIN

UNION SIMPLE MÂLE D'ORIENTATION FORME E DIN 385

GERADER AUFSTECKSTUTZEN GUMMIDICHTUNG FORM E

DIN 3852 – METRISCH-ZYLINDRISCH / BEL-BES

RACOR TUBO ROSCADO CON TUERCA Y ANILLO FORMA E DIN 3852

F1 Metrisch, Metrico, Metric, Métrique, Métrico

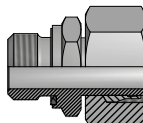

Note: AMM10ELTL06.1 for body only
AMM10ELTL06 for nut and cutting ring included

Code	Thread	Dimensions				Pressure		Series
		F1	T1	H	L1	L2	Bar	
		mm	mm	mm	mm			
AMM10ELTL06.1	10X1	6	14	8	32,5	315	4568	L
AMM12ELTL08.1	12X1,5	8	17	12	38,5	315	4568	L
AMM14ELTL10.1	14X1,5	10	19	12	39	315	4568	L
AMM16ELTL12.1	16X1,5	12	22	12	42,5	315	4568	L
AMM18ELTL15.1	18X1,5	15	24	12	43,5	315	4568	L
AMM22ELTL18.1	22X1,5	18	27	14	45,5	315	4568	L
AMM26ELTL22.1	26X1,5	22	32	16	48,5	160	2320	L
AMM33ELTL28.1	33X2	28	41	18	53,5	160	2320	L
AMM42ELTL35.1	42X2	35	50	20	62,5	160	2320	L
AMM48ELTL42.1	48X2	42	55	22	68,5	160	2320	L
AMM12ELTS06.1	12X1,5	6	17	12	39	630	9137	S
AMM14ELTS08.1	14X1,5	8	19	12	41,5	630	9137	S
AMM16ELTS10.1	16X1,5	10	22	12	44	630	9137	S
AMM18ELTS12.1	18X1,5	12	24	12	46	630	9137	S
AMM20ELTS14.1	20X1,5	14	27	14	50,5	630	9137	S
AMM22ELTS16.1	22X1,5	16	27	14	51	400	5801	S
AMM27ELTS20.1	27X2	20	32	16	59	400	5801	S
AMM33ELTS25.1	33X2	25	41	18	66	400	5801	S
AMM42ELTS30.1	42X2	30	50	20	71	250	3626	S
AMM48ELTS38.1	48X2	38	55	22	82	250	3626	S

NPT MALE-DIN STUD STANDPIPE

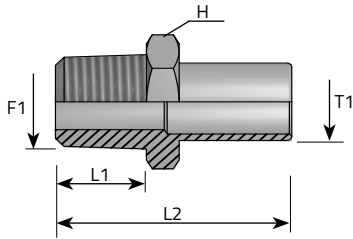

ADATTATORE DIRITTO MASCHIO NPT – TUBO DIN
 UNION SIMPLE MÂLE D'ORIENTATION
 GERADER AUFSTECKSTUTZEN – NPT / BEL-BES
 RACOR TUBO ROSCADO CON TUERCA Y ANILLO

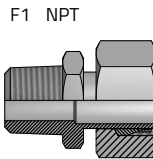

*Note: AMN02TL06.1 for body only
 AMN02TL06 for nut and cutting ring included*

Code	Thread	Dimensions				Pressure		Series
		T1	H	L1	L2	Bar	Psi	
	F1	mm	mm	mm	mm			
AMN02TL06.1	1/8"	6	12	10	33	315	4568	L
AMN04TL08.1	1/4"	8	14	15	39	315	4568	L
AMN04TL10.1	1/4"	10	14	15	40	315	4568	L
AMN06TL12.1	3/8"	12	19	15	44,5	315	4568	L
AMN08TL15.1	1/2"	15	22	20	48	315	4568	L
AMN08TL18.1	1/2"	18	22	20	49	315	4568	L
AMN12TL22.1	3/4"	22	27	20	49	160	2320	L
AMN16TL28.1	1"	28	36	25	55,5	160	2320	L
AMN20TL35.1	1.1/4"	35	46	26	63	160	2320	L
AMN24TL42.1	1.1/2"	42	50	26	65	160	2320	L
AMN04TS06.1	1/4"	6	14	15	40	630	9137	S
AMN04TS08.1	1/4"	8	14	15	40	630	9137	S
AMN06TS10.1	3/8"	10	19	15	44	630	9137	S
AMN06TS12.1	3/8"	12	19	15	44,5	630	9137	S
AMN08TS14.1	1/2"	14	22	20	53,5	630	9137	S
AMN08TS16.1	1/2"	16	22	20	53,5	400	5801	S
AMN12TS20.1	3/4"	20	27	20	58	400	5801	S
AMN16TS25.1	1"	25	36	25	68,5	400	5801	S
AMN20TS30.1	1.1/4"	30	46	26	73,5	400	5801	S
AMN24TS38.1	1.1/2"	38	50	26	78	315	4568	S

DIN MALE STUD ELBOW-BSPP MALE

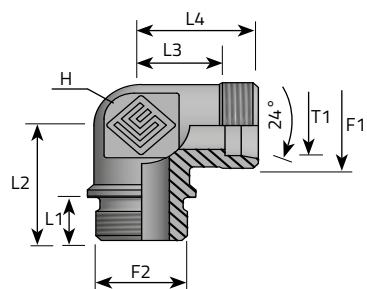

GOMITO 90° MASCHIO DIN – MASCHIO GAS CILINDRICO
 COUDE MÂLE DIN/BSPP
 WINKEL-EINSCHRAUBVERSCHRAUBUNG 90° FORM B DIN 3852 – 24°
 RACOR EN CODO DIN/BSPP

F1 Metrisch, Metrico, Metric, Métrique, Métrico

F2 Zylinder-Gasgewinde, Gas cilindrico, BSPP, Gaz cylindrique,
 Gas cilíndrica

Code	Thread		Dimensions						Pressure		Series
	F1	F2	T1	H	L1	L2	L3	L4	Bar	Psi	
LME22LMG12.1	30X2	3/4"	22	27	16	26	27,5	35	160	2320	L
LME28LMG16.1	36X2	1"	28	36	18	30	30,5	38	160	2320	L
LME35LMG20.1	45X2	1.1/4"	35	41	20	55	34,5	45	160	2320	L
LME42LMG24.1	52X2	1.1/2"	42	50	22	39	40	51	160	2320	L
LME20SMG12.1	30X2	3/4"	20	27	16	26	26,5	37	400	5801	S
LME25SMG16.1	36X2	1"	25	36	18	30	31	43	400	5801	S
LME30SMG20.1	42X2	1.1/4"	30	41	20	55	35,5	49	250	3626	S
LME38SMG24.1	52X2	1.1/2"	38	50	22	39	41	57	250	3626	S

DIN MALE STUD ELBOW-METRIC MALE

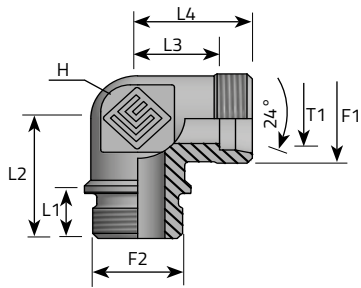

GOMITO 90° MASCHIO DIN – MASCHIO METRICO FORMA B
 COUDE MÂLE DIN/METRIC
 WINKEL-EINSCHRAUBVERSCHRAUBUNG 90° FORM B
 RACOR EN CODO DIN/METRICO

F1 Metrisch, Metrico, Metric, Métrique, Métrico

F2 Metrisch, Metrico, Metric, Métrique, Métrico

Code	Thread		Dimensions						Pressure		Series
	F1	F2	T1	H	L1	L2	L3	L4	Bar	Psi	
LME22LMM26.1	30X2	26X1,5	22	27	16	26	27,5	35	160	2320	L
LME28LMM33.1	36X2	33X2	28	36	18	30	30,5	38	160	2320	L
LME35LMM42.1	45X2	42X2	35	41	20	55	34,5	45	160	2320	L
LME42LMM48.1	52X2	48X2	42	50	22	39	40	51	160	2320	L
LME20SMM27.1	30X2	27X2	20	27	16	26	26,5	37	400	5801	S
LME25SMM33.1	36X2	33X2	25	36	18	30	31	43	400	5801	S
LME30SMM42.1	42X2	42X2	30	41	20	55	35,5	49	250	3626	S
LME38SMM48.1	52X2	48X2	38	50	22	39	41	57	250	3626	S

DIN MALE STUD ELBOW-BSPT MALE (1)

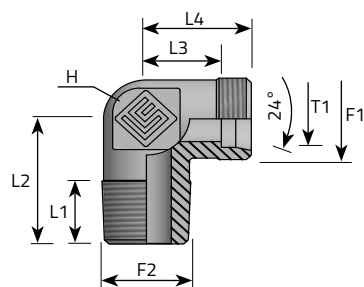

GOMITO 90° MASCHIO DIN – MASCHIO GAS CONICO
 COUDE MÂLE DIN/BSPT
 WINKEL-EINSCHRAUBVERSCHRAUBUNG 90° – 24° METRISCH / AGR-K
 RACOR EN CODO DIN/BSPT

F1 Metrisch, Metrico, Metric, Métrique, Métrico

F2 Keglige-Gasgewinde, Gas conico, BSPT, Gaz conique,
 Rosca conica

Code	Thread		Dimensions						Pressure		Series
	F1	F2	T1	H	L1	L2	L3	L4	Bar	Psi	
			mm	mm	mm	mm	mm	mm			
LME06LMGK02.1	12x1,5	1/8"	6	12	8	20	12	19	315	4568	L
LME06LMGK04.1	12x1,5	1/4"	6	12	12	26	14	21	315	4568	L
LME08LMGK02.1	14x1,5	1/8"	8	12	8	26	14	21	315	4568	L
LME08LMGK04.1	14x1,5	1/4"	8	12	12	26	14	21	315	4568	L
LME08LMGK06.1	14x1,5	3/8"	8	17	12	28	17	24	315	4568	L
LME08LMGK08.1	14x1,5	1/2"	8	19	14	34	19	26	315	4568	L
LME10LMGK02.1	16x1,5	1/8"	10	14	8	22	15	22	315	4568	L
LME10LMGK04.1	16x1,5	1/4"	10	14	12	27	15	22	315	4568	L
LME10LMGK06.1	16x1,5	3/8"	10	17	12	28	17	24	315	4568	L
LME10LMGK08.1	16x1,5	1/2"	10	19	14	34	21	28	315	4568	L
LME12LMGK04.1	18x1,5	1/4"	12	17	12	28	17	24	315	4568	L
LME12LMGK06.1	18x1,5	3/8"	12	17	12	28	17	24	315	4568	L
LME12LMGK08.1	18x1,5	1/2"	12	19	14	34	21	28	315	4568	L
LME15LMGK06.1	22x1,5	3/8"	15	19	12	34	21	28	315	4568	L
LME15LMGK08.1	22x1,5	1/2"	15	19	14	34	21	28	315	4568	L
LME18LMGK08.1	26x1,5	1/2"	18	24	14	36	23,5	31	315	4568	L
LME18LMGK12.1	26x1,5	3/4"	18	27	16	42	26,5	34	315	4568	L
LME22LMGK12.1	30x2	3/4"	22	27	16	47	27,5	35	160	2320	L
LME28LMGK16.1	36x2	1"	28	36	18	48	30,5	38	160	2320	L
LME35LMGK20.1	45x2	1.1/4"	35	41	20	54	34,5	45	160	2320	L
LME42LMGK24.1	52x2	1.1/2"	42	50	22	61	40	51	160	2320	L

DIN MALE STUD ELBOW-BSPT MALE (2)

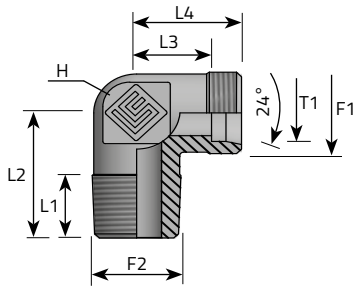

GOMITO 90° MASCHIO DIN – MASCHIO GAS CONICO
 COUDE MÂLE DIN/BSPT
 WINKEL-EINSCHRAUBVERSCHRAUBUNG 90° – 24° METRISCH / AGR-K
 RACOR EN CODO DIN/BSPT

F1 Metrisch, Metrico, Metric, Métrique, Métrico

F2 Keglige-Gasgewinde, Gas conico, BSPT, Gaz conique,
 Rosca conica

Code	Thread		Dimensions						Pressure		Series
	F1	F2	T1	H	L1	L2	L3	L4	Bar	Psi	
			mm	mm	mm	mm	mm	mm			
LME06SMGK04.1	14x1,5	1/4"	6	12	12	26	16	23	630	9137	L
LME08SMGK04.1	16x1,5	1/4"	8	14	12	27	17	24	630	9137	S
LME10SMGK06.1	18x1,5	3/8"	10	17	12	28	17,5	25	630	9137	S
LME12SMGK06.1	20x1,5	3/8"	12	17	12	28	21,5	29	630	9137	S
LME12SMGK08.1	20x1,5	1/2"	12	19	14	32	22,5	30	630	9137	S
LME14SMGK06.1	22x1,5	3/8"	14	19	12	30	22	30	630	9137	S
LME14SMGK08.1	22x1,5	1/2"	14	19	14	32	22	30	630	9137	S
LME16SMGK06.1	24x1,5	3/8"	16	24	12	32	24,5	33	400	5801	S
LME16SMGK08.1	24x1,5	1/2"	16	24	14	32	24,5	33	400	5801	S
LME20SMGK08.1	30x2	1/2"	20	27	14	36	26,5	37	400	5801	S
LME20SMGK12.1	30x2	3/4"	20	27	16	47	26,5	37	400	5801	S
LME25SMGK12.1	36x2	3/4"	25	36	16	42	30	42	400	5801	S
LME25SMGK16.1	36x2	1"	25	36	18	48	30	42	400	5801	S
LME30SMGK16.1	42x2	1"	30	41	18	48	35,5	49	400	5801	S
LME30SMGK20.1	42x2	1.1/4"	30	41	20	54	35,5	49	400	5801	S
LME38SMGK24.1	52x2	1.1/2"	38	50	22	61	41	57	315	4568	S

DIN MALE STUD ELBOW-METRIC TAPER

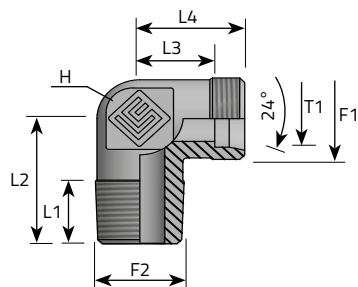

GOMITO 90° MASCHIO DIN – MASCHIO METRICO CONICO
COUDE MÂLE DIN/ MÉTRICO CÔNICO
 WINKEL-EINSCHRAUBVERSCHRAUBUNG 90° – 24° METRISCH /
 METRISCH-KONISCH
RACOR EN CODO DIN/ MÉTRICO CÔNICO

F1 Metrisch, Metrico, Metric, Métrique, Métrico

F2 Kegeliges metrisches Gewinde, Metrico conico,
 Metric taper, Métrique conique, Métrico cónico

Code	Thread		Dimensions						Pressure		Series
	F1	F2	T1	H	L1	L2	L3	L4	Bar	Psi	
			mm	mm	mm	mm	mm	mm			
LME06LMMK10.1	12X1,5	10X1	6	12	8	20	12	19	315	4568	L
LME08LMMK12.1	14X1,5	12X1,5	8	12	12	26	14	21	315	4568	L
LME10LMMK14.1	16X1,5	14X1,5	10	14	12	27	15	22	315	4568	L
LME12LMMK16.1	18X1,5	16X1,5	12	17	12	28	17	24	315	4568	L
LME15LMMK18.1	22X1,5	18X1,5	15	19	14	34	21	28	315	4568	L
LME18LMMK22.1	26X1,5	22X1,5	18	24	14	36	23,5	31	315	4568	L
LME06SMMK12.1	14X1,5	12X1,5	6	12	12	26	16	23	630	9137	S
LME08SMMK14.1	16X1,5	14X1,5	8	14	12	27	17	24	630	9137	S
LME10SMMK16.1	18X1,5	16X1,5	10	17	12	28	17,5	25	630	9137	S
LME12SMMK18.1	20X1,5	18X1,5	12	17	12	31	21,5	29	630	9137	S
LME14SMMK20.1	22X1,5	20X1,5	14	19	14	32	22	30	630	9137	S
LME16SMMK22.1	24X1,5	22X1,5	16	24	14	32	24,5	33	400	5801	S

DIN MALE STUD ELBOW-NPT MALE (1)

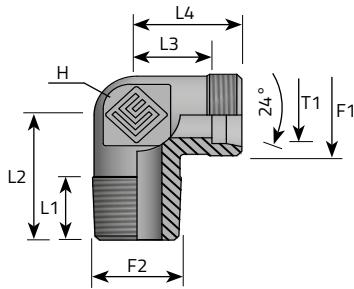

GOMITO 90° MASCHIO DIN – MASCHIO NPT
 COUDE MÂLE DIN/NPT
 WINKEL-EINSCHRAUBVERSCHRAUBUNG 90° – 24° METRISCH / AGN
 RACOR EN CODO DIN/NPT

F1 Metrisch, Metrico, Metric, Métrique, Métrico

F2 NPT

Code	Thread		Dimensions						Pressure		Series
	F1	F2	T1	H	L1	L2	L3	L4	Bar	Psi	
			mm	mm	mm	mm	mm	mm			
LME06LMN02.1	12X1,5	1/8"	6	12	8	20	12	19	315	4568	L
LME06LMN04.1	12X1,5	1/4"	6	12	12	26	14	21	315	4568	L
LME08LMN02.1	14X1,5	1/8"	8	12	8	26	14	21	315	4568	L
LME08LMN04.1	14X1,5	1/4"	8	12	12	26	14	21	315	4568	L
LME08LMN06.1	14X1,5	3/8"	8	17	12	28	17	24	315	4568	L
LME08LMN08.1	14X1,5	1/2"	8	19	14	34	19	26	315	4568	L
LME10LMN02.1	16X1,5	1/8"	10	14	8	22	15	22	315	4568	L
LME10LMN04.1	16X1,5	1/4"	10	14	12	27	15	22	315	4568	L
LME10LMN06.1	16X1,5	3/8"	10	17	12	28	17	24	315	4568	L
LME10LMN08.1	16X1,5	1/2"	10	19	14	34	21	28	315	4568	L
LME12LMN04.1	18X1,5	1/4"	12	17	12	28	17	24	315	4568	L
LME12LMN06.1	18X1,5	3/8"	12	17	12	28	17	24	315	4568	L
LME12LMN08.1	18X1,5	1/2"	12	19	14	34	21	28	315	4568	L
LME15LMN06.1	22X1,5	3/8"	15	19	12	34	21	28	315	4568	L
LME15LMN08.1	22X1,5	1/2"	15	19	14	34	21	28	315	4568	L
LME18LMN08.1	26X1,5	1/2"	18	24	14	36	23,5	31	315	4568	L
LME18LMN12.1	26X1,5	3/4"	18	27	16	42	26,5	34	315	4568	L
LME22LMN12.1	30X2	3/4"	22	27	16	42	27,5	35	160	2320	L
LME28LMN16.1	36X2	1"	28	36	18	48	30,5	38	160	2320	L
LME35LMN20.1	45X2	1.1/4"	35	41	20	54	34,5	45	160	2320	L
LME42LMN24.1	52X2	1.1/2"	42	50	22	61	40	51	160	2320	L

DIN MALE STUD ELBOW-NPT MALE (2)

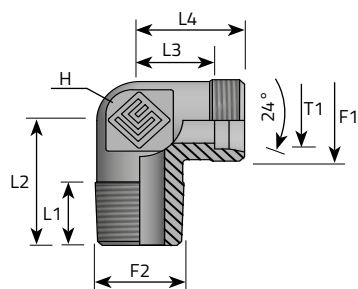

GOMITO 90° MASCHIO DIN – MASCHIO NPT
 COUDE MÂLE DIN/NPT
 WINKEL-EINSCHRAUBVERSCHRAUBUNG 90° – 24° METRISCH / AGN
 RACOR EN CODO DIN/NPT

F1 Metrisch, Metrico, Metric, Métrique, Métrico

F2 NPT

Code	Thread		Dimensions						Pressure		Series
	F1	F2	T1	H	L1	L2	L3	L4	Bar	Psi	
			mm	mm	mm	mm	mm	mm			
LME06SMN04.1	14X1,5	1/4"	6	12	12	26	16	23	630	9137	L
LME08SMN04.1	16X1,5	1/4"	8	14	12	27	17	24	630	9137	S
LME10SMN06.1	18X1,5	3/8"	10	17	12	28	17,5	25	630	9137	S
LME12SMN06.1	20X1,5	3/8"	12	17	12	28	21,5	29	630	9137	S
LME12SMN08.1	20X1,5	1/2"	12	19	14	32	22,5	30	630	9137	S
LME14SMN06.1	22X1,5	3/8"	14	19	12	30	22	30	630	9137	S
LME14SMN08.1	22X1,5	1/2"	14	19	14	32	22	30	630	9137	S
LME16SMN06.1	24X1,5	3/8"	16	24	12	32	24,5	33	400	5801	S
LME16SMN08.1	24X1,5	1/2"	16	24	14	32	24,5	33	400	5801	S
LME20SMN08.1	30X2	1/2"	20	27	14	36	26,5	37	400	5801	S
LME20SMN12.1	30X2	3/4"	20	27	16	42	26,5	37	400	5801	S
LME25SMN12.1	36X2	3/4"	25	36	16	42	30	42	400	5801	S
LME25SMN16.1	36X2	1"	25	36	18	48	30	42	400	5801	S
LME30SMN16.1	42X2	1"	30	41	18	48	35,5	49	400	5801	S
LME30SMN20.1	42X2	1.1/4"	30	41	20	54	35,5	49	400	5801	S
LME38SMN24.1	52X2	1.1/2"	38	50	22	61	41	57	315	4568	S

T ADAPTER DIN MALE/DIN MALE/BSPP MALE

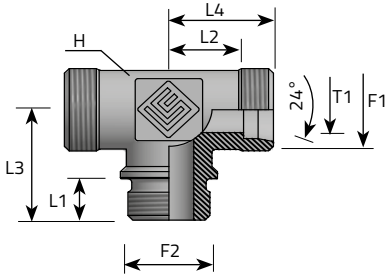

ADATTATORE T MASCHIO DIN – MASCHIO GAS CILINDRICO AL PIEDE
TÉ MÂLE DIN/DIN/BSPP
 T-EINSCHRAUBVERSCHRAUBUNG – 2 X DIN 24° / AGR-Z UNTEN
RACOR EN T DIN/DIN/BSPP

F1 Metrisch, Metrico, Metric, Métrique, Métrico

F2 Zylinder-Gasgewinde, Gas cilindrico, BSPP, Gaz cylindrique,
 Gas cilíndrica

Code	Thread		Dimensions						Pressure		Series
	F1	F2	T1	H	L1	L2	L3	L4	Bar	Psi	
			mm	mm	mm	mm	mm	mm			
TME22LMG12P.1	30X2	3/4"	22	27	16	27,5	26	35	160	2320	L
TME28LMG16P.1	36X2	1"	28	36	18	30,5	30	38	160	2320	L
TME35LMG20P.1	45X2	1.1/4"	35	41	20	55	34	65,5	160	2320	L
TME42LMG24P.1	52X2	1.1/2"	42	50	22	40	39	51	160	2320	L
TME20SMG12P.1	30X2	3/4"	20	27	16	26,5	26	37	400	5801	S
TME25SMG16P.1	36X2	1"	25	36	18	31	30	43	400	5801	S
TME30SMG20P.1	42X2	1.1/4"	30	41	20	55	34	68,5	250	3626	S
TME38SMG24P.1	52X2	1.1/2"	38	50	22	41	39	57	250	3626	S

T ADAPTER DIN MALE/DIN MALE/METRIC MALE

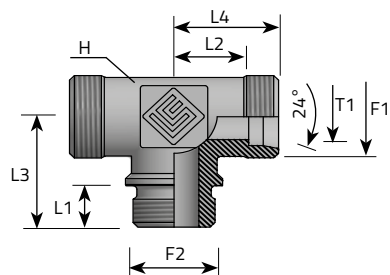

ADATTATORE T MASCHIO DIN – MASCHIO METRICO AL PIEDE
 TÉ MÂLE DIN/DIN/MÉTRIQUE
 T-EINSCHRAUBVERSCHRAUBUNG – 2 X DIN 24° / AGM-Z UNTEN
 RACOR EN T DIN/DIN/MÉTRICO

F1 Metrisch, Metrico, Metric, Métrique, Métrico

F2 Metrisch, Metrico, Metric, Métrique, Métrico

Code	Thread		Dimensions						Pressure		Series
	F1	F2	T1	H	L1	L2	L3	L4	Bar	Psi	
TME22LMM26P.1	30X2	26X1,5	22	27	16	27,5	26	35	160	2320	L
TME28LMM33P.1	36X2	33X2	28	36	18	30,5	30	38	160	2320	L
TME35LMM42P.1	45X2	42X2	35	41	20	34,5	34	65,5	160	2320	L
TME42LMM48P.1	52X2	48X2	42	50	22	40	39	51	160	2320	L
TME20SMM27P.1	30X2	27X2	20	27	16	26,5	26	37	400	5801	S
TME25SMM33P.1	36X2	33X2	25	36	18	31	30	43	400	5801	S
TME30SMM42P.1	42X2	42X2	30	41	20	35,5	34	68,5	250	3626	S
TME38SMM48P.1	52X2	48X2	38	50	22	41	39	57	250	3626	S

T ADAPTER DIN MALE/DIN MALE/BSPT MALE

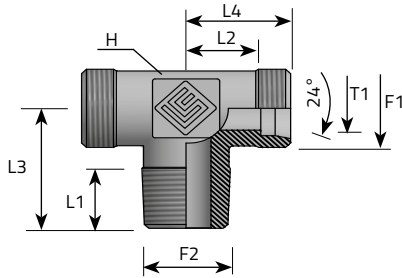

ADATTATORE T MASCHIO DIN – MASCHIO GAS CONICO AL PIEDE
 TÊ MÂLE DIN/DIN/BSPT
 T-EINSCHRAUBVERSCHRAUBUNG – 2 X DIN 24° / AGR-K UNTEN
 RACOR EN T DIN/DIN/BSPT

F1 Metrisch, Metrico, Metric, Métrique, Métrico

F2 Keglige-Gasgewinde, Gas conico, BSPT, Gaz conique, Rosca conica

Code	Thread		Dimensions						Pressure		Series
	F1	F2	T1	H	L1	L2	L3	L4	Bar	Psi	
			mm	mm	mm	mm	mm	mm			
TME06LMGK02P.1	12X1,5	1/8"	6	12	8	12	20	19	315	4568	L
TME08LMGK04P.1	14X1,5	1/4"	8	12	12	14	26	21	315	4568	L
TME10LMGK04P.1	16X1,5	1/4"	10	14	12	15	27	22	315	4568	L
TME12LMGK06P.1	18X1,5	3/8"	12	17	12	17	28	24	315	4568	L
TME15LMGK08P.1	22X1,5	1/2"	15	19	14	21	34	28	315	4568	L
TME18LMGK08P.1	26X1,5	1/2"	18	24	14	23,5	36	31	315	4568	L
TME22LMGK12P.1	30X2	3/4"	22	27	16	27,5	47	35	160	2320	L
TME28LMGK16P.1	36X2	1"	28	36	18	30,5	48	38	160	2320	L
TME35LMGK20P.1	45X2	1.1/4"	35	41	20	34,5	54	45	160	2320	L
TME42LMGK24P.1	52X2	1.1/2"	42	50	22	40	61	51	160	2320	L
TME06SMGK04P.1	14X1,5	1/4"	6	12	12	16	26	23	630	9137	S
TME08SMGK04P.1	16X1,5	1/4"	8	14	12	17	27	24	630	9137	S
TME10SMGK06P.1	18X1,5	3/8"	10	17	12	17,5	28	25	630	9137	S
TME12SMGK06P.1	20X1,5	3/8"	12	17	12	21,5	31	29	630	9137	S
TME14SMGK08P.1	22X1,5	1/2"	14	19	14	22	32	30	630	9137	S
TME16SMGK08P.1	24X1,5	1/2"	16	24	14	24,5	32	33	400	5801	S
TME20SMGK12P.1	30X2	3/4"	20	27	16	26,5	47	37	400	5801	S
TME25SMGK16P.1	36X2	1"	25	36	18	30	48	42	400	5801	S
TME30SMGK20P.1	42X2	1.1/4"	30	41	20	35,5	54	49	400	5801	S
TME38SMGK24P.1	52X2	1.1/2"	38	50	22	41	61	57	315	4568	S

T ADAPTER DIN MALE/DIN MALE/METRIC TAPER MALE

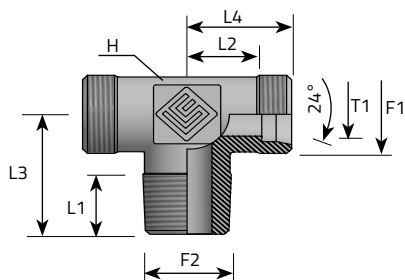

ADATTATORE T MASCHIO DIN – MASCHIO METRICO CONICO AL PIEDE
TÉ MÂLE DIN/DIN/MÉTRIQUE CONIQUE
 T-EINSCHRAUBVERSCHRAUBUNG – 2 X DIN 24° / AGM-K UNTEN
RACOR EN T DIN/DIN/MÉTRICO CÓNICO

F1 Metrisch, Metrico, Metric, Métrique, Métrico

F2 Kegeliges metrisches Gewinde, Metrico conico,
 Metric taper, Métrique conique, Métrico cónico

Code	Thread		Dimensions						Pressure		Series
	F1	F2	T1	H	L1	L2	L3	L4	Bar	Psi	
			mm	mm	mm	mm	mm	mm			
TME06LMMK10P.1	12X1,5	10X1	6	12	8	12	20	19	315	4568	L
TME08LMMK12P.1	14X1,5	12X1,5	8	12	12	14	26	21	315	4568	L
TME10LMMK14P.1	16X1,5	14X1,5	10	14	12	15	27	22	315	4568	L
TME12LMMK16P.1	18X1,5	16X1,5	12	17	12	17	28	24	315	4568	L
TME15LMMK18P.1	22X1,5	18X1,5	15	19	14	21	34	28	315	4568	L
TME18LMMK22P.1	26X1,5	22X1,5	18	24	14	23,5	36	31	315	4568	L
TME06SMMK12P.1	14X1,5	12X1,5	6	12	12	16	26	23	630	9137	S
TME08SMMK14P.1	16X1,5	14X1,5	8	14	12	17	27	24	630	9137	S
TME10SMMK16P.1	18X1,5	16X1,5	10	17	12	17,5	28	25	630	9137	S
TME12SMMK18P.1	20X1,5	18X1,5	12	17	12	21,5	31	29	630	9137	S
TME14SMMK20P.1	22X1,5	20X1,5	14	19	14	22	32	30	630	9137	S
TME16SMMK22P.1	24X1,5	22X1,5	16	24	14	24,5	32	33	400	5801	S

T ADAPTER DIN MALE/DIN MALE/NPT MALE

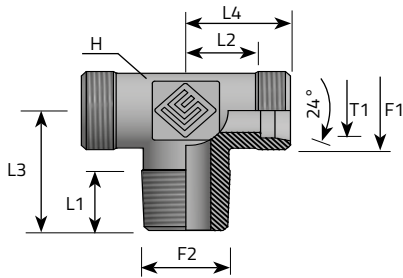

ADATTATORE T MASCHIO DIN – MASCHIO NPT AL PIEDE
TÉ MÂLE DIN/DIN/NPT
 T-EINSCHRAUBVERSCHRAUBUNG – 2 X DIN 24° / AGN UNTEN
RACOR EN T DIN/DIN/NPT

F1 Metrisch, Metrico, Metric, Métrique, Métrico

F2 NPT

Code	Thread		Dimensions						Pressure		Series
	F1	F2	T1	H	L1	L2	L3	L4	Bar	Psi	
			mm	mm	mm	mm	mm	mm			
TME06LMN02P.1	12X1,5	1/8"	6	12	8	12	20	19	315	4568	L
TME08LMN04P.1	14X1,5	1/4"	8	12	12	14	26	21	315	4568	L
TME10LMN04P.1	16X1,5	1/4"	10	14	12	15	27	22	315	4568	L
TME12LMN06P.1	18X1,5	3/8"	12	17	12	17	28	24	315	4568	L
TME15LMN08P.1	22X1,5	1/2"	15	19	14	21	34	28	315	4568	L
TME18LMN08P.1	26X1,5	1/2"	18	24	14	23,5	36	31	315	4568	L
TME22LMN12P.1	30X2	3/4"	22	27	16	27,5	42	35	160	2320	L
TME28LMN16P.1	36X2	1"	28	36	18	30,5	48	38	160	2320	L
TME35LMN20P.1	45X2	1.1/4"	35	41	20	34,5	54	45	160	2320	L
TME42LMN24P.1	52X2	1.1/2"	42	50	22	40	61	51	160	2320	L
TME06SMN04P.1	14X1,5	1/4"	6	12	12	16	26	23	630	9137	S
TME08SMN04P.1	16X1,5	1/4"	8	14	12	17	27	24	630	9137	S
TME10SMN06P.1	18X1,5	3/8"	10	17	12	17,5	28	25	630	9137	S
TME12SMN06P.1	20X1,5	3/8"	12	17	12	21,5	31	29	630	9137	S
TME14SMN08P.1	22X1,5	1/2"	14	19	14	22	32	30	630	9137	S
TME16SMN08P.1	24X1,5	1/2"	16	24	14	24,5	32	33	400	5801	S
TME20SMN12P.1	30X2	3/4"	20	27	16	26,5	42	37	400	5801	S
TME25SMN16P.1	36X2	1"	25	36	18	30	48	42	400	5801	S
TME30SMN20P.1	42X2	1.1/4"	30	41	20	35,5	54	49	400	5801	S
TME38SMN24P.1	52X2	1.1/2"	38	50	22	41	61	57	315	4568	S

T ADAPTER BSPP MALE/DIN MALE/DIN MALE

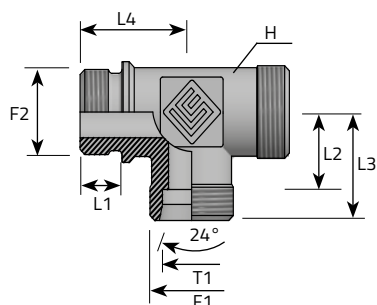

ADATTATORE T MASCHIO DIN – MASCHIO GAS CILINDRICO AL BRACCIO
 TÊ MÂLE BSPP/DIN/DIN
 L-EINSCHRAUBVERSCHRAUBUNG – 2 X DIN 24° / AGR-Z SEITLICH
 RACOR EN T BSPP/DIN/DIN

F1 Metrisch, Metrico, Metric, Métrique, Métrico

F2 Zylinder-Gasgewinde, Gas cilíndrico, BSPP, Gaz cylíndrique,
 Gas cilíndrica

Code	Thread		Dimensions						Pressure		Series
	F1	F2	T1	H	L1	L2	L3	L4	Bar	Psi	
			mm	mm	mm	mm	mm	mm			
TME22LMG12B.1	30X2	3/4"	22	27	16	27.5	26	35	160	2320	L
TME28LMG16B.1	36X2	1"	28	36	18	30.5	30	38	160	2320	L
TME35LMG20B.1	45X2	1.1/4"	35	41	20	55	34	45	160	2320	L
TME42LMG24B.1	52X2	1.1/2"	42	50	22	40	39	51	160	2320	L
TME20SMG12B.1	30X2	3/4"	20	27	16	26.5	26	37	400	5801	S
TME25SMG16B.1	36X2	1"	25	36	18	31	30	43	400	5801	S
TME30SMG20B.1	42X2	1.1/4"	30	41	20	55	34	49	250	3626	S
TME38SMG24B.1	52X2	1.1/2"	38	50	22	41	39	57	250	3626	S

T ADAPTER METRIC MALE/DIN MALE/DIN MALE

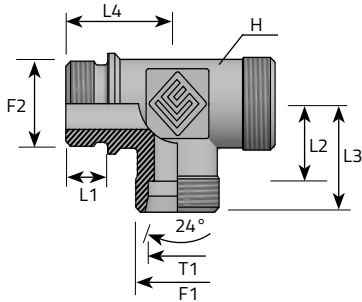

ADATTATORE T MASCHIO DIN – MASCHIO METRICO AL BRACCIO
 TÉ MÂLE MÉTRIQUE/DIN/DIN
 L-EINSCHRAUBVERSCHRAUBUNG – 2 X DIN 24° / AGN SEITLICH
 RACOR EN T MÉTRICO/DIN/DIN

F1 Metrisch, Metrico, Metric, Métrique, Métrico

F2 Metrisch, Metrico, Metric, Métrique, Métrico

Code	Thread		Dimensions						Pressure		Series
	F1	F2	T1	H	L1	L2	L3	L4	Bar	Psi	
			mm	mm	mm	mm	mm	mm			
TME22LMM26B.1	30X2	26X1,5	22	27	16	27,5	26	35	160	2320	L
TME28LMM33B.1	36X2	33X2	28	36	18	30,5	30	38	160	2320	L
TME35LMM42B.1	45X2	42X2	35	41	20	55	34	45	160	2320	L
TME42LMM48B.1	52X2	48X2	42	50	22	40	39	51	160	2320	L
TME20SMM27B.1	30X2	27X2	20	27	16	26,5	26	37	400	5801	S
TME25SMM33B.1	36X2	33X2	25	36	18	31	30	43	400	5801	S
TME30SMM42B.1	42X2	42X2	30	41	20	55	34	49	250	3626	S
TME38SMM48B.1	52X2	48X2	38	50	22	41	39	57	250	3626	S

T ADAPTER METRIC TAPER MALE/DIN MALE/DIN MALE

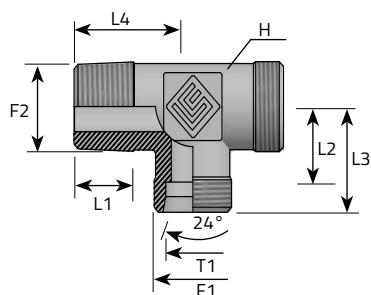

ADATTATORE T MASCHIO DIN – MASCHIO METRICO CONICO AL BRACCIO
 TÉ MÂLE MÉTRIQUE CONIQUE/DIN/DIN/
 T-EINSCHRAUBVERSCHRAUBUNG – 2 X DIN 24° / AGM-K UNTEN
 RACOR EN T MÉTRICO CÓNICO/DIN/DIN

F1 Metrisch, Metrico, Metric, Métrique, Métrico

F2 Kegeliges metrisches Gewinde, Metrico conico,
 Metric taper, Métrique conique, Métrico cónico

Code	Thread		Dimensions						Pressure		Series
	F1	F2	T1	H	L1	L2	L3	L4	Bar	Psi	
TME06LMMK10B.1	12X1,5	10X1	6	12	8	12	19	27	315	4568	L
TME08LMMK12B.1	14X1,5	12X1,5	8	12	12	14	21	29	315	4568	L
TME10LMMK14B.1	16X1,5	14X1,5	10	14	12	15	22	30	315	4568	L
TME12LMMK16B.1	18X1,5	16X1,5	12	17	12	17	24	32	315	4568	L
TME15LMMK18B.1	22X1,5	18X1,5	15	19	14	21	28	36	315	4568	L
TME18LMMK22B.1	26X1,5	22X1,5	18	24	14	23.5	31	40	315	4568	L
TME06SMMK12B.1	14X1,5	12X1,5	6	12	12	16	23	31	630	9137	S
TME08SMMK14B.1	16X1,5	14X1,5	8	14	12	17	24	32	630	9137	S
TME10SMMK16B.1	18X1,5	16X1,5	10	17	12	17.5	25	34	630	9137	S
TME12SMMK18B.1	20X1,5	18X1,5	12	17	12	21.5	29	38	630	9137	S
TME14SMMK20B.1	22X1,5	20X1,5	14	19	14	22	30	40	630	9137	S
TME16SMMK22B.1	24X1,5	22X1,5	16	24	14	24.5	33	43	400	5801	S

T ADAPTER BSPT MALE/DIN MALE/DIN MALE

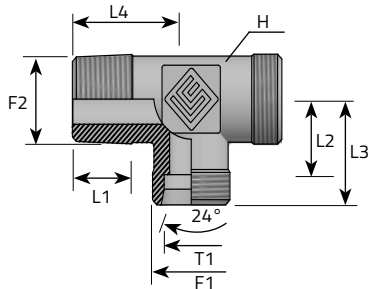

ADATTATORE T MASCHIO DIN – MASCHIO METRICO AL BRACCIO
 TÊ MÂLE BSPT/DIN/DIN
 L-EINSCHRAUBVERSCHRAUBUNG – 2 X DIN 24° / AGR-K SEITLICH
 RACOR EN T BSPT/DIN/DIN

F1 Metrisch, Metrico, Metric, Métrique, Métrico
 F2 Keglige-Gasgewinde, Gas conico, BSPT, Gaz conique, Rosca conica

Code	Thread		Dimensions						Pressure		Series
	F1	F2	T1	H	L1	L2	L3	L4	Bar	Psi	
			mm	mm	mm	mm	mm	mm			
TME06LMGK02B.1	12X1,5	1/8"	6	12	8	12	19	27	315	4568	L
TME08LMGK04B.1	14X1,5	1/4"	8	12	12	14	21	29	315	4568	L
TME10LMGK04B.1	16X1,5	1/4"	10	14	12	15	22	30	315	4568	L
TME12LMGK06B.1	18X1,5	3/8"	12	17	12	17	24	32	315	4568	L
TME15LMGK08B.1	22X1,5	1/2"	15	19	14	21	28	36	315	4568	L
TME18LMGK08B.1	26X1,5	1/2"	18	24	14	23,5	31	40	315	4568	L
TME22LMGK12B.1	30X2	3/4"	22	27	16	27,5	35	44	160	2320	L
TME28LMGK16B.1	36X2	1"	28	36	18	30,5	38	47	160	2320	L
TME35LMGK20B.1	45X2	1.1/4"	35	41	20	34,5	45	56	160	2320	L
TME42LMGK24B.1	52X2	1.1/2"	42	50	22	40	51	63	160	2320	L
TME06SMGK04B.1	14X1,5	1/4"	6	12	12	16	23	31	630	9137	S
TME08SMGK04B.1	16X1,5	1/4"	8	14	12	17	24	32	630	9137	S
TME10SMGK06B.1	18X1,5	3/8"	10	17	12	17,5	25	34	630	9137	S
TME12SMGK06B.1	20X1,5	3/8"	12	17	12	21,5	29	38	630	9137	S
TME14SMGK08B.1	22X1,5	1/2"	14	19	14	22	30	40	630	9137	S
TME16SMGK08B.1	24X1,5	1/2"	16	24	14	24,5	33	43	400	5801	S
TME20SMGK12B.1	30X2	3/4"	20	27	16	26,5	37	48	400	5801	S
TME25SMGK16B.1	36X2	1"	25	36	18	30	42	54	400	5801	S
TME30SMGK20B.1	42X2	1.1/4"	30	41	20	35,5	49	62	400	5801	S
TME38SMGK24B.1	52X2	1.1/2"	38	50	22	41	57	72	315	4568	S

T ADAPTER NPT MALE/DIN MALE/DIN MALE

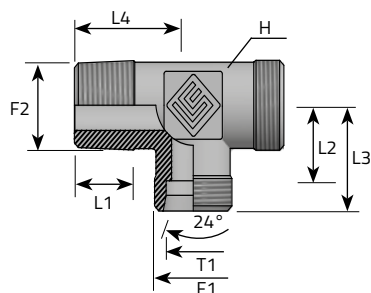

ADATTATORE T MASCHIO DIN – MASCHIO NPT AL BRACCIO
 TÊ MÂLE NPT/DIN/DIN
 L-EINSCHRAUBVERSCHRAUBUNG – 2 X DIN 24° / AGN SEITLICH
 RACOR EN T NPT/DIN/DIN

F1 Metrisch, Metrico, Metric, Métrique, Métrico

F2 NPT

Code	Thread		Dimensions						Pressure		Series
	F1	F2	T1	H	L1	L2	L3	L4	Bar	Psi	
			mm	mm	mm	mm	mm	mm			
TME06LMN02B.1	12X1,5	1/8"	6	12	8	12	19	27	315	4568	L
TME08LMN04B.1	14X1,5	1/4"	8	12	12	14	21	29	315	4568	L
TME10LMN04B.1	16X1,5	1/4"	10	14	12	15	22	30	315	4568	L
TME12LMN06B.1	18X1,5	3/8"	12	17	12	17	24	32	315	4568	L
TME15LMN08B.1	22X1,5	1/2"	15	19	14	21	28	36	315	4568	L
TME18LMN08B.1	26X1,5	1/2"	18	24	14	23,5	31	40	315	4568	L
TME22LMN12B.1	30X2	3/4"	22	27	16	27,5	35	44	160	2320	L
TME28LMN16B.1	36X2	1"	28	36	18	30,5	38	47	160	2320	L
TME35LMN20B.1	45X2	1.1/4"	35	41	20	34,5	45	56	160	2320	L
TME42LMN24B.1	52X2	1.1/2"	42	50	22	40	51	63	160	2320	L
TME06SMN04B.1	14X1,5	1/4"	6	12	12	16	23	31	630	9137	S
TME08SMN04B.1	16X1,5	1/4"	8	14	12	17	24	32	630	9137	S
TME10SMN06B.1	18X1,5	3/8"	10	17	12	17,5	25	34	630	9137	S
TME12SMN06B.1	20X1,5	3/8"	12	17	12	21,5	29	38	630	9137	S
TME14SMN08B.1	22X1,5	1/2"	14	19	14	22	30	40	630	9137	S
TME16SMN08B.1	24X1,5	1/2"	16	24	14	24,5	33	43	400	5801	S
TME20SMN12B.1	30X2	3/4"	20	27	16	26,5	37	48	400	5801	S
TME25SMN16B.1	36X2	1"	25	36	18	30	42	54	400	5801	S
TME30SMN20B.1	42X2	1.1/4"	30	41	20	35,5	49	62	400	5801	S
TME38SMN24B.1	52X2	1.1/2"	38	50	22	41	57	72	315	4568	S

DIN MALE STUD ELBOW-BSPP MALE ADJUSTABLE

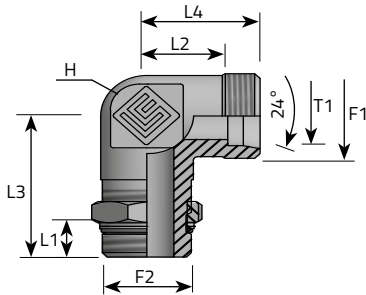

GOMITO 90° MASCHIO DIN – MASCHIO GAS CILINDRICO ORIENTABILE
 COUDE ORIENTABLE AVEC CONTRE ÉCROU DIN/BSPP
 EINSTELLBARE WINKELVERSCHRÄUBUNG 90° MIT KONTERMUTTER –
 24° METRISCH / AGR-Z
 RACOR ORIENTABLE CODO CON CONTRATUERCA DIN/BSPP

F1 Metrisch, Metrico, Metric, Métrique, Métrico

F2 Zylinder-Gasgewinde, Gas cilindrico, BSPP, Gaz cylindrique,
 Gas cilíndrica

Code	Thread		Dimensions						Pressure		Series
	F1	F2	T1	H	L1	L2	L3	L4	Bar	Psi	
			mm	mm	mm	mm	mm	mm			
LME06LMOG02.1	12X1,5	1/8"	6	14	6,3	14	20,2	21	315	4568	L
LME08LMOG04.1	14X1,5	1/4"	8	14	9,5	16	22,5	23	315	4568	L
LME10LMOG04.1	16X1,5	1/4"	10	14	9,5	15	24,5	22	315	4568	L
LME12LMOG06.1	18X1,5	3/8"	12	19	9,5	19	27,5	26	250	3626	L
LME15LMOG08.1	22X1,5	1/2"	15	22	13	21	30	28	250	3626	L
LME18LMOG08.1	26X1,5	1/2"	18	27	13	24	36,5	31,5	250	3626	L
LME22LMOG12.1	30X2	3/4"	22	27	13	28	37,5	35,5	160	2320	L
LME28LMOG16.1	36X2	1"	28	33	16	31	41	38,5	160	2320	L
LME35LMOG20.1	45X2	1.1/4"	35	41	16	38	49	48,5	160	2320	L
LME42LMOG24.1	52X2	1.1/2"	42	48	16	38	51	49	160	2320	L
LME06SMOG04.1	14X1,5	1/4"	6	14	9,5	15,5	22,5	22,5	315	4568	S
LME08SMOG04.1	16X1,5	1/4"	8	14	9,5	18	26,5	25	315	4568	S
LME10SMOG06.1	18X1,5	3/8"	10	19	9,5	18	28,5	25,5	250	3626	S
LME12SMOG06.1	20X1,5	3/8"	12	19	9,5	22	28,5	29,5	250	3626	S
LME14SMOG08.1	22X1,5	1/2"	14	22	13	22	31	30	250	3626	S
LME16SMOG08.1	24X1,5	1/2"	16	27	13	25	36	33,5	250	3626	S
LME20SMOG12.1	30X2	3/4"	20	27	13	28	38	38,5	250	3626	S
LME25SMOG16.1	36X2	1"	25	33	16	30,5	41	42,5	250	3626	S
LME30SMOG20.1	42X2	1.1/4"	30	41	16	36	48	49,5	160	2320	S
LME38SMOG24.1	52X2	1.1/2"	38	48	16	34	53	50	160	2320	S

DIN MALE STUD ELBOW-METRIC MALE ADJUSTABLE

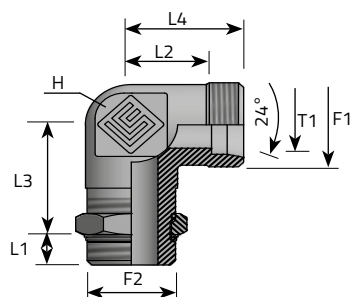

GOMITO 90° MASCHIO DIN – MASCHIO METRICO ORIENTABILE
 COUDE ORIENTABLE AVEC CONTRE ÉCROU DIN/ MÉTRIQUE
 EINSTELLBARE WINKELVERSCHRAUBUNG 90° MIT KONTERMUTTER –
 24° METRISCH / AGM-Z
 RACOR ORIENTABLE CODO CON CONTRATUERCA DIN/ MÉTRICO

F1 Metrisch, Metrico, Metric, Métrique, Métrico

F2 Metrisch, Metrico, Metric, Métrique, Métrico

Code	Thread		Dimensions						Pressure		Series
	F1	F2	T1	H	L1	L2	L3	L4	Bar	Psi	
			mm	mm	mm	mm	mm	mm			
LME06LMOM10.1	12X1,5	10X1	6	14	8,5	14	19	21	315	4568	L
LME08LMOM12.1	14X1,5	12X1,5	8	14	11	16	21	23	315	4568	L
LME10LMOM14.1	16X1,5	14X1,5	10	14	11	17	24	24	315	4568	L
LME12LMOM16.1	18X1,5	16X1,5	12	19	11,5	19	24,5	26	250	3626	L
LME15LMOM18.1	22X1,5	18X1,5	15	22	12,5	21	28,5	28	250	3626	L
LME18LMOM22.1	26X1,5	22X1,5	18	27	12,5	24	32,5	31,5	250	3626	L
LME22LMOM27.1	30X2	27X2	22	27	15,5	28	34	35,5	160	2320	L
LME28LMOM33.1	36X2	33X2	28	33	15,5	31	38,5	38,5	160	2320	L
LME35LMOM42.1	45X2	42X2	35	41	15,5	38	46,5	48,5	160	2320	L
LME42LMOM48.1	52X2	48X2	42	48	17	38	48	49	160	2320	L
LME06SMOM12.1	14X1,5	12X1,5	6	14	11	15,5	22	22,5	400	5801	S
LME08SMOM14.1	16X1,5	14X1,5	8	14	11	18	25	25	400	5801	S
LME10SMOM16.1	18X1,5	16X1,5	10	19	12,5	18	25,5	25,5	400	5801	S
LME12SMOM18.1	20X1,5	18X1,5	12	19	14	22	29	29,5	400	5801	S
LME16SMOM22.1	24X1,5	22X1,5	16	27	14,5	25	35,5	33,5	400	5801	S
LME20SMOM27.1	30X2	27X2	20	27	16	28	37,5	38,5	400	5801	S
LME25SMOM33.1	36X2	33X2	25	33	16	30,5	41	42,5	315	4568	S
LME30SMOM42.1	42X2	42X2	30	41	18	36	50	49,5	250	3626	S
LME38SMOM48.1	52X2	48X2	38	48	20	34	49	50	200	2901	S

DIN METRIC STUD ELBOW-METRIC MALE ADJUSTABLE

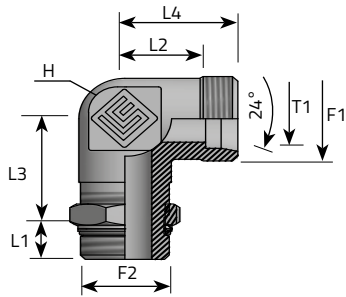

GOMITO 90° M.DIN – M. METRICO ORIENTABILE CON O-RING
 COUDE ORIENTABLE AVEC CONTRE ÉCROU – O-RING DIN/ MÉTRIQUE
 EINSTELLBARE WINKELVERSCHRAUBUNG 90° MIT KONTERMUTTER +
 BEWEGLICHE UNTERLEGSCHIEBE + O-RING – 24° METRISCH / AGM-Z
 RACOR ORIENTABLE, CODO CON CONTRATUERCA – ARANDELA DE
 RETENCIÓN JUNTA TORICA DIN/ MÉTRICO

F1 Metrisch, Metrico, Metric, Métrique, Métrico

F2 Metrisch, Metrico, Metric, Métrique, Métrico

Code	Thread		Dimensions						Pressure		Series
	F1	F2	T1	H	L1	L2	L3	L4	Bar	Psi	
			mm	mm	mm	mm	mm	mm			
LME06LMOMR10.1	12X1,5	10X1	6	14	7,5	14	20	21	315	4568	L
LME08LMOMR12.1	14X1,5	12X1,5	8	14	9,5	16	22,5	23	315	4568	L
LME10LMOMR14.1	16X1,5	14X1,5	10	14	9,5	17	25,5	24	315	4568	L
LME12LMOMR16.1	18X1,5	16X1,5	12	19	10	19	26	26	315	4568	L
LME15LMOMR18.1	22X1,5	18X1,5	15	22	11	21	30	28	315	4568	L
LME18LMOMR22.1	26X1,5	22X1,5	18	27	11	24	34	31,5	250	3626	L
LME22LMOMR27.1	30X2	27X2	22	27	13,5	28	36	35,5	160	2320	L
LME28LMOMR33.1	36X2	33X2	28	33	13,5	31	40,5	38,5	160	2320	L
LME35LMOMR42.1	45X2	42X2	35	41	13,5	38	48,5	48,5	160	2320	L
LME42LMOMR48.1	52X2	48X2	42	48	15	38	50	49	160	2320	L
LME06SMOMR12.1	14X1,5	12X1,5	6	14	9,5	15,5	23,5	22,5	315	4568	S
LME08SMOMR14.1	16X1,5	14X1,5	8	14	9,5	18	26,5	25	315	4568	S
LME10SMOMR16.1	18X1,5	16X1,5	10	19	11	18	27	25,5	315	4568	S
LME12SMOMR18.1	20X1,5	18X1,5	12	19	12,5	22	30,5	29,5	315	4568	S
LME16SMOMR22.1	24X1,5	22X1,5	16	27	13	25	37	33,5	250	3626	S
LME20SMOMR27.1	30X2	27X2	20	27	14	28	39,5	38,5	250	3626	S
LME25SMOMR33.1	36X2	33X2	25	33	14	30,5	43	42,5	160	2320	S
LME30SMOMR42.1	42X2	42X2	30	41	16	36	52	49,5	160	2320	S
LME38SMOMR48.1	52X2	48X2	38	48	18	34	51	50	160	2320	S

DIN MALE STUD ELBOW-UNF MALE ADJUSTABLE

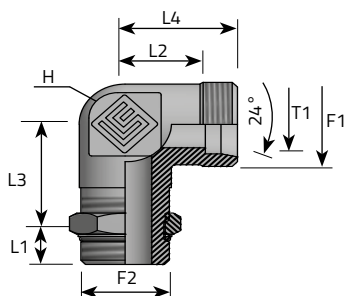

GOMITO 90° MASCHIO DIN – MASCHIO UNF ORIENTABILE
 COUDE ORIENTABLE AVEC CONTRE ÉCROU DIN/UNF
 EINSTELLBARE WINKELVERSCHRAUBUNG 90° MIT KONTERMUTTER –
 24° METRISCH / UNF-Z
 RACOR ORIENTABLE CODO CON CONTRATUERCA DIN/UNF

F1 Metrisch, Metrico, Metric, Métrique, Métrico

F2 UNF

Code	Thread		Dimensions						Pressure		Series
	F1	F2	T1	H	L1	L2	L3	L4	Bar	Psi	
			mm	mm	mm	mm	mm	mm			
LME06LMOU04.1	12x1,5	7/16"	6	14	9	14	20	21	315	4568	L
LME08LMOU04.1	14x1,5	7/16"	8	14	9	16	20	23	315	4568	L
LME10LMOU06.1	16x1,5	9/16"	10	14	10	17	24	24	315	4568	L
LME12LMOU06.1	18x1,5	9/16"	12	19	10	19	26	26	315	4568	L
LME12LMOU08.1	18x1,5	3/4"	12	19	11	19	26,5	26	315	4568	L
LME15LMOU08.1	22x1,5	3/4"	15	22	11	21	30	28	315	4568	L
LME15LMOU10.1	22x1,5	7/8"	15	22	12,7	21	30,3	28	315	4568	L
LME18LMOU10.1	26x1,5	7/8"	18	27	12,7	24	34,3	28,5	315	4568	L
LME18LMOU12.1	26x1,5	1.1/16"	18	27	15	24,5	35	28,5	315	4568	L
LME22LMOU12.1	30x2	1.1/16"	22	27	15	28	37	31,5	160	2320	L
LME28LMOU16.1	36x2	1.5/16"	28	33	15	31	42	32	160	2320	L
LME35LMOU20.1	45x2	1.5/8"	35	41	15	38	48	35	160	2320	L
LME42LMOU24.1	52x2	1.7/8"	42	48	15	38	49	39	160	2320	L
LME06SMOU04.1	14x1,5	7/16"	6	14	9	15,5	23	38	400	5801	S
LME08SMOU06.1	16x1,5	9/16"	8	14	10	18	27	45	400	5801	S
LME10SMOU06.1	18x1,5	9/16"	10	19	10	18	27,5	45,5	400	5801	S
LME12SMOU08.1	20x1,5	3/4"	12	19	11	22	33	23	400	5801	S
LME14SMOU10.1	22x1,5	7/8"	14	22	12,7	22	31,3	26	400	5801	S
LME16SMOU10.1	24x1,5	7/8"	16	27	12,7	25	37,3	26,5	400	5801	S
LME20SMOU12.1	30x2	1.1/16"	20	27	15	28	38	32,5	400	5801	S
LME25SMOU12.1	36x2	1.1/16"	25	33	15	30,5	42	34	400	5801	S
LME30SMOU20.1	42x2	1.5/8"	30	41	15	36	54	38,5	250	3626	S
LME38SMOU24.1	52x2	1.7/8"	38	48	15	34	54	44	250	3626	S

T ADAPTER DIN MALE/DIN MALE/BSPP MALE ADJUSTABLE

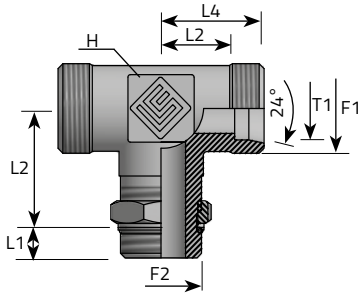

ADATTATORE T MASCHIO DIN – MASCHIO GAS CILINDRICO ORIENTABILE
AL PIEDE

TÉ ORIENTABLE AVEC CONTRE ÉCROU DIN/DIN/BSPP

EINSTELLBARER T-ANSCHLUSSSTUTZEN MIT KONTERMUTTER – 2 X DIN
24° / AGR-Z UNTEN

RACOR ORIENTABLE EN T CON CONTROTUERCA DIN/DIN/BSPP

F1 Metrisch, Metrico, Metric, Métrique, Métrico

F2 Zylinder-Gasgewinde, Gas cilindrico, BSPP, Gaz cylindrique,
Gas cilíndrica

Code	Thread		Dimensions						Pressure		Series
	F1	F2	T1	H	L1	L2	L3	L4	Bar	Psi	
			mm	mm	mm	mm	mm	mm			
TME06LMOG02P.1	12X1,5	1/8"	6	14	6,3	14	20,2	21	315	4568	L
TME08LMOG04P.1	14X,15	1/4"	8	14	9,5	16	22,5	23	315	4568	L
TME10LMOG04P.1	16X1,5	1/4"	10	19	9,5	17	24,5	24	315	4568	L
TME12LMOG06P.1	18X1,5	3/8"	12	19	9,5	19	27,5	26	250	3626	L
TME15LMOG08P.1	22X1,5	1/2"	15	22	13	21	30	28	250	3626	L
TME18LMOG08P.1	26X1,5	1/2"	18	27	13	24	36,5	31,5	250	3626	L
TME22LMOG12P.1	30X2	3/4"	22	33	13	28	37,5	35,5	160	2320	L
TME28LMOG16P.1	36X2	1"	28	41	16	31	41	38,5	160	2320	L
TME35LMOG20P.1	45X2	1.1/4"	35	48	16	38	49	48,5	160	2320	L
TME42LMOG24P.1	52X2	1.1/2"	42	48	16	38	51	49	160	2320	L
TME06SMOG04P.1	14X1,5	1/4"	6	14	9,5	15,5	22,5	22,5	315	4568	S
TME08SMOG04P.1	16X1,5	1/4"	8	19	9,5	18	26,5	25	315	4568	S
TME10SMOG06P.1	18X1,5	3/8"	10	19	9,5	18	28,5	25,5	250	3626	S
TME12SMOG06P.1	20X1,5	3/8"	12	22	9,5	22	28,5	29,5	250	3626	S
TME14SMOG08P.1	22X1,5	1/2"	14	22	13	22	31	30	250	3626	S
TME16SMOG08P.1	24X1,5	1/2"	16	27	13	25	36	33,5	250	3626	S
TME20SMOG12P.1	30X2	3/4"	20	27	13	28	38	38,5	250	3626	S
TME25SMOG16P.1	36X2	1"	25	33	16	30,5	41	42,5	250	3626	S
TME30SMOG20P.1	42X2	1.1/4"	30	48	16	36	48	49,5	160	2320	S
TME38SMOG24P.1	52X2	1.1/2"	38	48	16	34	53	50	160	2320	S

T ADAPTER DIN MALE/DIN MALE/METRIC MALE ADJUSTABLE

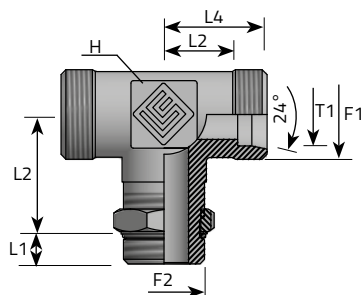

ADATTATORE T MASCHIO DIN – MASCHIO METRICO ORIENTABILE AL PIEDE

TÉ ORIENTABLE AVEC CONTRE ÈCROU DIN/DIN/ MÉTRIQUE
EINSTELLBARER T-ANSCHLUSSSTUTZEN MIT KONTERMUTTER –
2 X DIN 24° REDUZIERT / AGM-Z UNTEN REDUZIERT

RACOR ORIENTABLE EN T CON CONTROTUERCA DIN/DIN/ MÉTRICO

F1 Metrisch, Metrico, Metric, Métrique, Métrico

F1 Metrisch, Metrico, Metric, Métrique, Métrico

Code	Thread		Dimensions						Pressure		Series
	F1	F2	T1	H	L1	L2	L3	L4	Bar	Psi	
			mm	mm	mm	mm	mm	mm			
TME06LMOM10P.1	12X1,5	10X1	6	14	8,5	14	19	21	315	4568	L
TME08LMOM12P.1	14X1,5	12X1,5	8	14	11	16	21	23	315	4568	L
TME10LMOM14P.1	16X1,5	14X1,5	10	14	11	17	24	24	315	4568	L
TME12LMOM16P.1	18X1,5	16X1,5	12	19	11,5	19	24,5	26	250	3626	L
TME15LMOM18P.1	22X1,5	18X1,5	15	22	12,5	21	28,5	28	250	3626	L
TME18LMOM22P.1	26X1,5	22X1,5	18	27	12,5	24	32,5	31,5	250	3626	L
TME22LMOM27P.1	30X2	27X2	22	27	15,5	28	34	35,5	160	2320	L
TME28LMOM33P.1	36X2	33X2	28	33	15,5	31	38,5	38,5	160	2320	L
TME35LMOM42P.1	45X2	42X2	35	41	15,5	38	46,5	48,5	160	2320	L
TME42LMOM48P.1	52X2	48X2	42	48	17	38	48	49	160	2320	L
TME06SMOM12P.1	14X1,5	12X1,5	6	14	11	15,5	22	22,5	400	5801	S
TME08SMOM14P.1	16X1,5	14X1,5	8	14	11	18	25	25	400	5801	S
TME10SMOM16P.1	18X1,5	16X1,5	10	19	12,5	18	25,5	25,5	400	5801	S
TME12SMOM18P.1	20X1,5	18X1,5	12	19	14	22	29	29,5	400	5801	S
TME16SMOM22P.1	24X1,5	22X1,5	16	27	14,5	25	35,5	33	400	5801	S
TME20SMOM27P.1	30X2	27X2	20	27	16	28	37,5	38,5	400	5801	S
TME25SMOM33P.1	36X2	33X2	25	33	16	30,5	41	42,5	315	4568	S
TME30SMOM42P.1	42X2	42X2	30	41	18	36	50	49,5	250	3626	S
TME38SMOM48P.1	52X2	48X2	38	48	20	34	49	50	200	2901	S

T ADAPTER DIN MALE/DIN MALE/METRIC MALE ADJUSTABLE

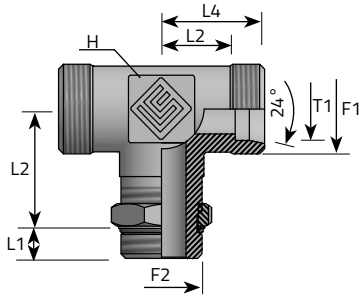

ADATTATORE T MASCHIO DIN – MASCHIO METRICO ORIENTAB. AL PIEDE
 TÉ ORIENTABLE AVEC CONTRE ÈCROU DIN/DIN/ MÉTRIQUE
 EINSTELLBARER T-ANSCHLUSSSTUTZEN MIT KONTERMUTTER –
 2 X DIN 24° REDUZIERT / AGM-Z UNTEN REDUZIERT
 RACOR ORIENTABLE EN T CON CONTROTUERCA DIN/DIN/ MÉTRICO

F1 Metrisch, Metrico, Metric, Métrique, Métrico

F2 Metrisch, Metrico, Metric, Métrique, Métrico

Code	Thread		Dimensions						Pressure		Series
	F1	F2	T1	H	L1	L2	L3	L4	Bar	Psi	
			mm	mm	mm	mm	mm	mm			
TME06LMOMR10P.1	12X1,5	10X1	6	14	7,5	14	20	21	315	4568	L
TME08LMOMR12P.1	14X1,5	12X1,5	8	14	9,5	16	22,5	23	315	4568	L
TME10LMOMR14P.1	16X1,5	14X1,5	10	14	9,5	17	25,5	24	315	4568	L
TME12LMOMR16P.1	18X1,5	16X1,5	12	19	10	19	26	26	315	4568	L
TME15LMOMR18P.1	22X1,5	18X1,5	15	22	11	21	30	28	315	4568	L
TME18LMOMR22P.1	26X1,5	22X1,5	18	27	11	24	34	31,5	250	3626	L
TME22LMOMR27P.1	30X2	27X2	22	27	13,5	28	36	35,5	160	2320	L
TME28LMOMR33P.1	36X2	33X2	28	33	13,5	31	40,5	38,5	160	2320	L
TME35LMOMR42P.1	45X2	42X2	35	41	13,5	38	48,5	48,5	160	2320	L
TME42LMOMR48P.1	52X2	48X2	42	48	15	38	50	49	160	2320	L
TME06SMOMR12P.1	14X1,5	12X1,5	6	14	9,5	15,5	23,5	22,5	315	4568	S
TME08SMOMR14P.1	16X1,5	14X1,5	8	14	9,5	18	26,5	25	315	4568	S
TME10SMOMR16P.1	18X1,5	16X1,5	10	19	11	18	27	25,5	315	4568	S
TME12SMOMR18P.1	20X1,5	18X1,5	12	19	12,5	22	30,5	29,5	315	4568	S
TME16SMOMR22P.1	24X1,5	22X1,5	16	27	13	25	37	33	250	3626	S
TME20SMOMR27P.1	30X2	27X2	20	27	14	28	39,5	38,5	250	3626	S
TME25SMOMR33P.1	36X2	33X2	25	33	14	30,5	43	42,5	160	2320	S
TME30SMOMR42P.1	42X2	42X2	30	41	16	36	52	49,5	160	2320	S
TME38SMOMR48P.1	52X2	48X2	38	48	18	34	51	50	160	2320	S

T ADAPTER DIN MALE/DIN MALE/UNF MALE ADJUSTABLE

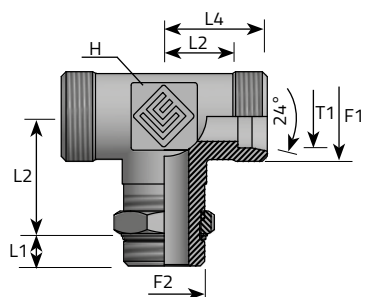

ADATTATORE T MASCHIO DIN – MASCHIO UNF ORIENTABILE AL PIEDE
 TÉ ORIENTABLE AVEC CONTRE ÉCROU DIN/DIN/UNF
 EINSTELLBARER T-ANSCHLUSSSTUTZEN MIT KONTERMUTTER – 2 X DIN
 24° / UNF-Z UNTEN
 RACOR ORIENTABLE EN T CON CONTROTUERCA DIN/DIN/UNF

F1 Metrisch, Metrico, Metric, Métrique, Métrico

F2 UNF

Code	Thread		Dimensions						Pressure		Series
	F1	F2	T1	H	L1	L2	L3	L4	Bar	Psi	
			mm	mm	mm	mm	mm	mm			
TME06LMOU04P.1	12X1,5	7/16"	6	14	9	14	20	21	250	3626	L
TME08LMOU04P.1	14X1,5	7/16"	8	14	9	16	20	23	250	3626	L
TME10LMOU06P.1	16X1,5	9/16"	10	14	10	17	24	24	250	3626	L
TME12LMOU06P.1	18X1,5	9/16"	12	19	10	19	26	26	250	3626	L
TME12LMOU08P.1	18X1,5	3/4"	12	19	11	19	26,5	26	250	3626	L
TME15LMOU08P.1	22X1,5	3/4"	15	22	11	21	30	28	250	3626	L
TME15LMOU10P.1	22X1,5	7/8"	15	22	12,7	21	30,3	28	250	3626	L
TME18LMOU10P.1	26X1,5	7/8"	18	27	12,7	24	34,3	31,5	250	3626	L
TME18LMOU12P.1	26X1,5	1.1/16"	18	27	15	24,5	35	32	250	3626	L
TME22LMOU12P.1	30X2	1.1/16"	22	27	15	28	37	35,5	160	2320	L
TME28LMOU16P.1	36X2	1.5/16"	28	33	15	31	42	38,5	160	2320	L
TME35LMOU20P.1	45X2	1.5/8"	35	41	15	38	48	48,5	160	2320	L
TME42LMOU24P.1	52X2	1.7/8"	42	48	15	38	49	49	160	2320	L
TME06SMOU04P.1	14X1,5	7/16"	6	14	9	15,5	23	22,5	400	5801	S
TME08SMOU06P.1	16X1,5	9/16"	8	14	10	18	27	25	400	5801	S
TME10SMOU06P.1	18X1,5	9/16"	10	19	10	18	27,5	25,5	400	5801	S
TME12SMOU08P.1	20X1,5	3/4"	12	19	11	22	33	29,5	400	5801	S
TME14SMOU10P.1	22X1,5	7/8"	14	22	12,7	22	31,3	30	400	5801	S
TME16SMOU10P.1	24X1,5	7/8"	16	27	12,7	25	37,3	33,5	400	5801	S
TME20SMOU12P.1	30X2	1.1/16"	20	27	15	28	38	38,5	400	5801	S
TME25SMOU16P.1	36X2	1.5/16"	25	33	15	30,5	42	42,5	400	5801	S
TME30SMOU20P.1	42X2	1.5/8"	30	41	15	36	54	49,5	250	3626	S
TME38SMOU24P.1	52X2	1.7/8"	38	48	15	34	54	50	250	3626	S

T ADAPTER BSPP MALE ADJUSTABLE/DIN MALE/DIN MALE

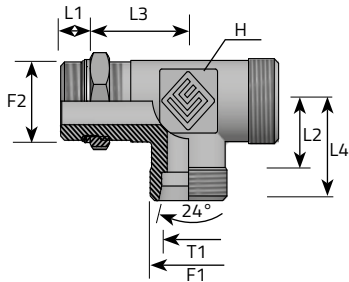

ADATTATORE T MASCHIO DIN – MASCHIO GAS CILINDRICO ORIENTABILE
AL BRACCIO
TÉ ORIENTABLE AVEC CONTRE ÈCROU BSPP/DIN/DIN
EINSTELLBARE L-VERSCHRAUBUNG MIT KONTERMUTTER –
2 X DIN 24° / AGR-Z REDUZIERT
RACOR ORIENTABLE EN T CON CONTROTUERCA BSPP/DIN/DIN

F1 Metrisch, Metrico, Metric, Métrique, Métrico

F2 Zylinder-Gasgewinde, Gas cilindrico, BSPP, Gaz cylindrique,
Gas cilíndrica

Code	Thread		Dimensions						Pressure		Series
	F1	F2	T1	H	L1	L2	L3	L4	Bar	Psi	
			mm	mm	mm	mm	mm	mm			
TME06LMOG02B.1	12X1,5	1/8"	6	14	6,3	14	20,2	21	315	4568	L
TME08LMOG04B.1	14X,15	1/4"	8	14	9,5	16	22,5	23	315	4568	L
TME10LMOG04B.1	16X1,5	1/4"	10	14	9,5	15	24,5	22	315	4568	L
TME12LMOG06B.1	18X1,5	3/8"	12	19	9,5	19	27,5	26	250	3626	L
TME15LMOG08B.1	22X1,5	1/2"	15	22	13	21	30	28	250	3626	L
TME18LMOG08B.1	26X1,5	1/2"	18	27	13	24	36,5	31,5	250	3626	L
TME22LMOG12B.1	30X2	3/4"	22	27	13	28	37,5	35,5	160	2320	L
TME28LMOG16B.1	36X2	1"	28	33	16	31	41	38,5	160	2320	L
TME35LMOG20B.1	45X2	1.1/4"	35	41	16	38	49	48,5	160	2320	L
TME42LMOG24B.1	52X2	1.1/2"	42	48	16	38	51	49	160	2320	L
TME06SMOG04B.1	14X1,5	1/4"	6	14	9,5	15,5	22,5	22,5	315	4568	S
TME08SMOG04B.1	16X1,5	1/4"	8	14	9,5	18	26,5	25	315	4568	S
TME10SMOG06B.1	18X1,5	3/8"	10	19	9,5	18	28,5	25,5	250	3626	S
TME12SMOG06B.1	20X1,5	3/8"	12	19	9,5	22	28,5	29,5	250	3626	S
TME14SMOG08B.1	22X15	1/2"	14	22	13	22	31	30	250	3626	S
TME16SMOG08B.1	24X1,5	1/2"	16	27	13	25	36	33,5	250	3626	S
TME20SMOG12B.1	30X2	3/4"	20	27	13	28	38	38,5	250	3626	S
TME25SMOG16B.1	36X2	1"	25	33	16	30,5	41	42,5	250	3626	S
TME30SMOG20B.1	42X2	1.1/4"	30	41	16	36	48	49,5	160	2320	S
TME38SMOG24B.1	52X2	1.1/2"	38	48	16	34	53	50	160	2320	S

T ADAPTER METRIC MALE ADJUSTABLE/DIN MALE/DIN MALE

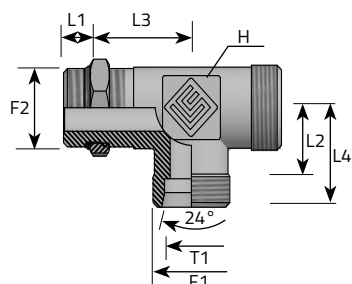

ADATTATORE T MASCHIO DIN – MASCHIO METRICO ORIENTABILE AL BRACCIO

TÉ ORIENTABLE AVEC CONTRE ÈCRO MÉTRIQUE/DIN/DIN
EINSTELLBARE L-ANSCHLUSSSTUTZEN MIT KONTERMUTTER –
2 X DIN 24° / AGM-Z UNTEN REDUZIERT

RACOR ORIENTABLE EN T CON CONTROTUERCA MÉTRICO/DIN/DIN

F1 Metrisch, Metrico, Metric, Métrique, Métrico

F2 Metrisch, Metrico, Metric, Métrique, Métrico

Code	Thread		Dimensions						Pressure		Series
	F1	F2	T1	H	L1	L2	L3	L4	Bar	Psi	
			mm	mm	mm	mm	mm	mm			
TME06LMOM10B.1	12X1,5	10X1	6	14	8,5	14	19	21	315	4568	L
TME08LMOM12B.1	14X1,5	12X1,5	8	14	11	16	21	23	315	4568	L
TME10LMOM14B.1	16X1,5	14X1,5	10	14	11	17	24	24	315	4568	L
TME12LMOM16B.1	18X1,5	16X1,5	12	19	11,5	19	24,5	26	250	3626	L
TME15LMOM18B.1	22X1,5	18X1,5	15	22	12,5	21	28,5	28	250	3626	L
TME18LMOM22B.1	26X1,5	22X1,5	18	27	12,5	24	32,5	31,5	250	3626	L
TME22LMOM27B.1	30X2	27X2	22	27	15,5	28	34	35,5	160	2320	L
TME28LMOM33B.1	36X2	33X2	28	33	15,5	31	38,5	38,5	160	2320	L
TME35LMOM42B.1	45X2	42X2	35	41	15,5	38	46,5	48,5	160	2320	L
TME42LMOM48B.1	52X2	48X2	42	48	17	38	48	49	160	2320	L
TME06SMOM12B.1	14X1,5	12X1,5	6	14	11	15,5	22	22,5	400	5801	S
TME08SMOM14B.1	16X1,5	14X1,5	8	14	11	18	25	25	400	5801	S
TME10SMOM16B.1	18X1,5	16X1,5	10	19	12,5	18	25,5	25,5	400	5801	S
TME12SMOM18B.1	20X1,5	18X1,5	12	19	14	22	29	29,5	400	5801	S
TME16SMOM22B.1	24X1,5	22X1,5	16	27	14,5	25	35,5	33	400	5801	S
TME20SMOM27B.1	30X2	27X2	20	27	16	28	37,5	38,5	400	5801	S
TME25SMOM33B.1	36X2	33X2	25	33	16	30,5	41	42,5	315	4568	S
TME30SMOM42B.1	42X2	42X2	30	41	18	36	50	49,5	250	3626	S
TME38SMOM48B.1	52X2	48X2	38	48	20	34	49	50	200	2901	S

T ADPTER METRIC MALE ADJUSTABLE/DIN MALE/DIN MALE

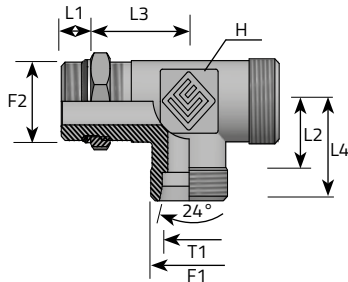

ADATTATORE T MASCHIO DIN – MASCHIO METRICO ORIENTABILE AL BRACCIO

TÉ ORIENTABLE AVEC CONTRE ÈCRO MÉTRIQUE/DIN/DIN
EINSTELLBARE L-ANSCHLUSSSTUTZEN MIT KONTERMUTTER –
2 X DIN 24° / AGM-Z UNTEN REDUZIERT

RACOR ORIENTABLE EN T CON CONTROTUERCA MÉTRICO/DIN/DIN

F1 Metrisch, Metrico, Metric, Métrique, Métrico

F2 Metrisch, Metrico, Metric, Métrique, Métrico

Code	Thread		Dimensions						Pressure		Series
	F1	F2	T1	H	L1	L2	L3	L4	Bar	Psi	
			mm	mm	mm	mm	mm	mm			
TME06LMOMR10B.1	12X1,5	10X1	6	14	7,5	14	20	21	315	4568	L
TME08LMOMR12B.1	14X1,5	12X1,5	8	14	9,5	16	22,5	23	315	4568	L
TME10LMOMR14B.1	16X1,5	14X1,5	10	14	9,5	17	25,5	24	315	4568	L
TME12LMOMR16B.1	18X1,5	16X1,5	12	19	10	19	26	26	315	4568	L
TME15LMOMR18B.1	22X1,5	18X1,5	15	22	11	21	30	28	315	4568	L
TME18LMOMR22B.1	26X1,5	22X1,5	18	27	11	24	34	31,5	250	3626	L
TME22LMOMR27B.1	30X2	27X2	22	27	13,5	28	36	35,5	160	2320	L
TME28LMOMR33B.1	36X2	33X2	28	33	13,5	31	40,5	38,5	160	2320	L
TME35LMOMR42B.1	45X2	42X2	35	41	13,5	38	48,5	48,5	160	2320	L
TME42LMOMR48B.1	52X2	48X2	42	48	15	38	50	49	160	2320	L
TME06SMOMR12B.1	14X1,5	12X1,5	6	14	9,5	15,5	23,5	22,5	315	4568	S
TME08SMOMR14B.1	16X1,5	14X1,5	8	14	9,5	18	26,5	25	315	4568	S
TME10SMOMR16B.1	18X1,5	16X1,5	10	19	11	18	27	25,5	315	4568	S
TME12SMOMR18B.1	20X1,5	18X1,5	12	19	12,5	22	30,5	29,5	315	4568	S
TME16SMOMR22B.1	24X1,5	22X1,5	16	27	13	25	37	33	250	3626	S
TME20SMOMR27B.1	30X2	27X2	20	27	14	28	39,5	38,5	250	3626	S
TME25SMOMR33B.1	36X2	33X2	25	33	14	30,5	43	42,5	160	2320	S
TME30SMOMR42B.1	42X2	42X2	30	41	16	36	52	49,5	160	2320	S
TME38SMOMR48B.1	52X2	48X2	38	48	18	34	51	50	160	2320	S

T ADAPERT UNF MALE ADJUSTABLE/DIN MALE/DIN MALE

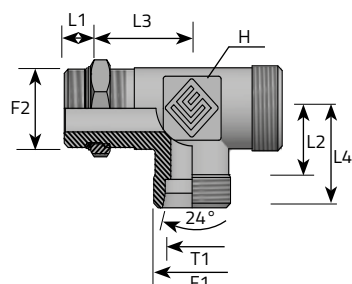

ADATTATORE T MASCHIO DIN – MASCHIO UNF ORIENTABILE AL BRACCIO
 TÉ ORIENTABLE AVEC CONTRE ÉCROU UNF/DIN/DIN
 EINSTELLBARE L-VERSCHRAUBUNG MIT KONTERMUTTER –
 2 X DIN 24° / UNF-Z REDUZIERT
 RACOR ORIENTABLE EN T CON CONTROTUERCA UNF/DIN/DIN

F1 Metrisch, Metrico, Metric, Métrique, Métrico

F2 UNF

Code	Thread		Dimensions						Pressure		Series
	F1	F2	T1	H	L1	L2	L3	L4	Bar	Psi	
			mm	mm	mm	mm	mm	mm			
TME06LMOU04B.1	12X1,5	7/16"	6	14	9	14	20	21	315	4568	L
TME08LMOU04B.1	14X1,5	7/16"	8	14	9	16	20	23	315	4568	L
TME10LMOU06B.1	16X1,5	9/16"	10	14	10	17	24	24	315	4568	L
TME12LMOU06B.1	18X1,5	9/16"	12	19	10	19	26	26	315	4568	L
TME12LMOU08B.1	18X1,5	3/4"	12	19	11	19	26,5	26	315	4568	L
TME15LMOU08B.1	22X1,5	3/4"	15	22	11	21	30	28	315	4568	L
TME15LMOU10B.1	22X1,5	7/8"	15	22	12,7	21	30,3	28	315	4568	L
TME18LMOU10B.1	26X1,5	7/8"	18	27	12,7	24	34,3	26,5	315	4568	L
TME18LMOU12B.1	26X1,5	1.1/16"	18	27	15	24,5	35	28,5	315	4568	L
TME22LMOU12B.1	30X2	1.1/16"	22	27	15	28	37	28,5	160	2320	L
TME28LMOU16B.1	36X2	1.5/16"	28	33	15	31	42	31,5	160	2320	L
TME35LMOU20B.1	45X2	1.5/8"	35	41	15	38	48	35	160	2320	L
TME42LMOU24B.1	52X2	1.7/8"	42	48	15	38	49	39	160	2320	L
TME06SMOU04B.1	14X1,5	7/16"	6	14	9	15,5	23	38	400	5801	S
TME08SMOU06B.1	16X1,5	9/16"	8	14	10	18	27	45	400	5801	S
TME10SMOU06B.1	18X1,5	9/16"	10	19	10	18	27,5	45,5	400	5801	S
TME12SMOU08B.1	20X1,5	3/4"	12	19	11	22	33	23	400	5801	S
TME14SMOU10B.1	22X1,5	7/8"	14	22	12,7	22	31,3	26	400	5801	S
TME16SMOU10B.1	24X1,5	7/8"	16	27	12,7	25	37,3	26,5	400	5801	S
TME20SMOU12B.1	30X2	1.1/16"	20	27	15	28	38	32,5	400	5801	S
TME25SMOU16B.1	36X2	1.5/16"	25	33	15	30,5	42	34	400	5801	S
TME30SMOU20B.1	42X2	1.5/8"	30	41	15	36	54	38,5	250	3626	S
TME38SMOU24B.1	52X2	1.7/8"	38	48	15	34	54	44	250	3626	S

DIN MALE 45° ELBOW - BSPP MALE ADJUSTABLE

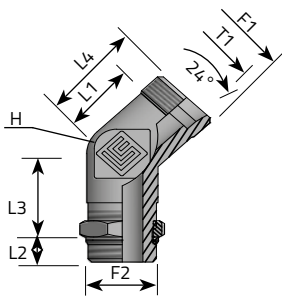

ADATTATORE 45° MASCHIO DIN – MASCHIO GAS CILINDRICO
ORIENTABILE
45° RENVERSÉ ORIENTABLE AVEC CONTRÈ ÈCROU DIN/BSPP
EINSTELLBARE 45°-VERSCHRAUBUNG MIT KONTERMUTTER –
DIN 24° / AGR-Z REDUZIERT
RACOR 45° ORIENTABLE CON CONTRATUERCA DIN/BSPP

F1 Metrisch, Metrico, Metric, Métrique, Métrico

F2 Zylinder-Gasgewinde, Gas cilindrico, BSPP, Gaz cylindrique,
Gas cilíndrica

Code	Thread		Dimensions						Pressure		Series
	F1	F2	T1	H	L1	L2	L3	L4	Bar	Psi	
			mm	mm	mm	mm	mm	mm			
QME06LMOG02.1	12X1,5	1/8"	6	14	6,3	9,5	21,7	13,3	315	4568	L
QME08LMOG04.1	14X1,5	1/4"	8	14	9,5	12	19,5	16,5	315	4568	L
QME10LMOG04.1	16X1,5	1/4"	10	14	9,5	12	24,5	16,5	315	4568	L
QME12LMOG06.1	18X1,5	3/8"	12	19	9,5	14	27,5	16,5	250	3626	L
QME15LMOG08.1	22X1,5	1/2"	15	22	13	17	26	20	250	3626	L
QME18LMOG08.1	26X1,5	1/2"	18	27	13	17	32	20,5	250	3626	L
QME22LMOG12.1	30X2	3/4"	22	27	13	19,5	37,5	20,5	160	2320	L
QME28LMOG16.1	36X2	1"	28	33	16	23	36	23,5	160	2320	L
QME35LMOG20.1	45X2	1.1/4"	35	41	16	27	38	26,5	160	2320	L
QME42LMOG24.1	52X2	1.1/2"	42	48	16	26	38	27	160	2320	L
QME06SMOG04.1	14X1,5	1/4"	6	14	9,5	11	18,5	16,5	315	4568	S
QME08SMOG04.1	16X1,5	1/4"	8	14	9,5	13	22,5	16,5	315	4568	S
QME10SMOG06.1	18X1,5	3/8"	10	19	9,5	13	24,5	17	250	3626	S
QME12SMOG06.1	20X1,5	3/8"	12	19	9,5	17	24,5	17	250	3626	S
QME14SMOG08.1	22X1,5	1/2"	14	22	13	16	25,5	21	250	3626	S
QME16SMOG08.1	24X1,5	1/2"	16	27	13	16	31	21,5	250	3626	S
QME20SMOG12.1	30X2	3/4"	20	27	13	19	33	23,5	250	3626	S
QME25SMOG16.1	36X2	1"	25	33	16	22	35	28	250	3626	S
QME30SMOG20.1	42X2	1.1/4"	30	41	16	24	37	29,5	160	2320	S
QME38SMOG24.1	52X2	1.1/2"	38	48	16	24	37	32	160	2320	S

DIN MALE 45° ELBOW - METRIC MALE ADJUSTABLE

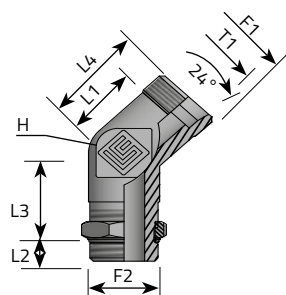

ADATTATORE 45° MASCHIO DIN – MASCHIO METRICO ORIENTABILE
 45° RENVERSÉ ORIENTABLE AVEC CONTRÈ ÈCROU DIN/ MÉTRIQUE
 EINSTELLBARE 45° -VERSCHRAUBUNG MIT KONTERMUTTER –
 DIN 24° / AGM-Z REDUZIERT
 RACOR 45° ORIENTABLE CON CONTRATERCA DIN/ MÉTRICO

F1 Metrisch, Metrico, Metric, Métrique, Métrico

F2 Metrisch, Metrico, Metric, Métrique, Métrico

Code	Thread		Dimensions						Pressure		Series
	F1	F2	T1	H	L1	L2	L3	L4	Bar	Psi	
			mm	mm	mm	mm	mm	mm			
QME06LMOM10.1	12X1,5	10X1	6	14	8,5	14	19	15,5	315	4568	L
QME08LMOM12.1	14X1,5	12X1,5	8	14	11	16	21	18	315	4568	L
QME10LMOM14.1	16X1,5	14X1,5	10	14	11	17	24	18	315	4568	L
QME12LMOM16.1	18X1,5	16X1,5	12	19	11,5	19	24,5	18,5	250	3626	L
QME15LMOM18.1	22X1,5	18X1,5	15	22	12,5	21	28,5	19,5	250	3626	L
QME18LMOM22.1	26X1,5	22X1,5	18	27	12,5	24	32,5	20	250	3626	L
QME22LMOM27.1	30X2	27X2	22	27	15,5	28	34	23	160	2320	L
QME28LMOM33.1	36X2	33X2	28	33	15,5	31	38,5	23	160	2320	L
QME35LMOM42.1	45X2	42X2	35	41	15,5	38	46,5	26	160	2320	L
QME42LMOM48.1	52X2	48X2	42	48	17	38	48	28	160	2320	L
QME06SMOM12.1	14X1,5	12X1,5	6	14	11	15,5	22	18	400	5801	S
QME08SMOM14.1	16X1,5	14X1,5	8	14	11	18	25	18	400	5801	S
QME10SMOM16.1	18X1,5	16X1,5	10	19	12,5	18	25,5	20	400	5801	S
QME12SMOM18.1	20X1,5	18X1,5	12	19	14	22	29	21,5	400	5801	S
QME16SMOM22.1	24X1,5	22X1,5	16	27	14,5	25	35,5	22,5	400	5801	S
QME20SMOM27.1	30X2	27X2	20	27	16	28	37,5	26,5	400	5801	S
QME25SMOM33.1	36X2	33X2	25	33	16	30,5	41	28	315	4568	S
QME30SMOM42.1	42X2	42X2	30	41	18	36	50	31,5	250	3626	S
QME38SMOM48.1	52X2	48X2	38	48	20	34	49	36	200	2901	S

DIN MALE 45° ELBOW - METRIC MALE ADJUSTABLE

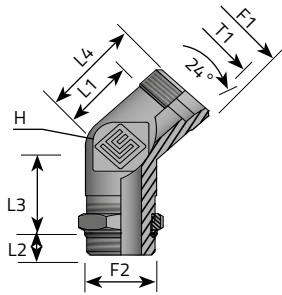

ADATTATORE 45° MASCHIO DIN – MASCHIO METRICO ORIENTABILE
 45° RENVERSÉ ORIENTABLE AVEC CONTRÈ ÈCROU DIN/MÉTRIQUE
 EINSTELLBARE 45°-VERSCHRAUBUNG MIT KONTERMUTTER –
 DIN 24° / AGM-Z REDUZIERT
 RACOR 45° ORIENTABLE CON CONTRATUERCA DIN/MÉTRICO

F1 Metrisch, Metrico, Metric, Métrique, Métrico

F2 Metrisch, Metrico, Metric, Métrique, Métrico

Code	Thread		Dimensions						Pressure		Series
	F1	F2	T1	H	L1	L2	L3	L4	Bar	Psi	
			mm	mm	mm	mm	mm	mm			
QME06LMOMR10.1	12X1,5	10X1	6	14	7,5	14	20	14,5	315	4568	L
QME08LMOMR12.1	14X1,5	12X1,5	8	14	9,5	16	22,5	16,5	315	4568	L
QME10LMOMR14.1	16X1,5	14X1,5	10	14	9,5	17	25,5	16,5	315	4568	L
QME12LMOMR16.1	18X1,5	16X1,5	12	19	10	19	26	17	250	3626	L
QME15LMOMR18.1	22X1,5	18X1,5	15	22	11	21	30	18	250	3626	L
QME18LMOMR22.1	26X1,5	22X1,5	18	27	11	24	34	18,5	250	3626	L
QME22LMOMR27.1	30X2	27X2	22	27	13,5	28	36	21	160	2320	L
QME28LMOMR33.1	36X2	33X2	28	33	13,5	31	40,5	21	160	2320	L
QME35LMOMR42.1	45X2	42X2	35	41	13,5	38	48,5	24	160	2320	L
QME42LMOMR48.1	52X2	48X2	42	48	15	38	50	26	160	2320	L
QME06SMOMR12.1	14X1,5	12X1,5	6	14	9,5	15,5	23,5	16,5	400	5801	S
QME08SMOMR14.1	16X1,5	14X1,5	8	14	9,5	18	26,5	16,5	400	5801	S
QME10SMOMR16.1	18X1,5	16X1,5	10	19	11	18	27	18,5	400	5801	S
QME12SMOMR18.1	20X1,5	18X1,5	12	19	12,5	22	30,5	20	400	5801	S
QME16SMOMR22.1	24X1,5	22X1,5	16	27	13	25	37	21	400	5801	S
QME20SMOMR27.1	30X2	27X2	20	27	14	28	39,5	24,5	400	5801	S
QME25SMOMR33.1	36X2	33X2	25	33	14	30,5	43	26	315	4568	S
QME30SMOMR42.1	42X2	42X2	30	41	16	36	52	29,5	250	3626	S
QME38SMOMR48.1	52X2	48X2	38	48	18	34	51	34	200	2901	S

DIN MALE 45° ELBOW - UNF MALE ADJUSTABLE

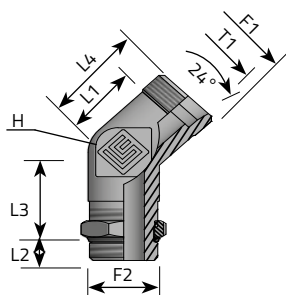

ADATTATORE 45° MASCHIO DIN – MASCHIO UNF ORIENTABILE
 45° RENVERSÉ ORIENTABLE AVEC CONTRÈ ÈCROU DIN/UNF
 EINSTELLBARE 45°-VERSCHRAUBUNG MIT KONTERMUTTER –
 DIN 24° / UNF-Z REDUZIERT
 RACOR 45° ORIENTABLE CON CONTRATUERCA DIN/UNF

F1 Metrisch, Metrico, Metric, Métrique, Métrico

F2 UNF

Code	Thread		Dimensions						Pressure		Series
	F1	F2	T1	H	L1	L2	L3	L4	Bar	Psi	
			mm	mm	mm	mm	mm	mm			
QME06LMOU04.1	12X1,5	7/16"	6	14	9	9,5	20	16	315	4568	L
QME08LMOU04.1	14X1,5	7/16"	8	14	9	12	20	16	315	4568	L
QME10LMOU06.1	16X1,5	9/16"	10	14	10	12	24	17	315	4568	L
QME12LMOU06.1	18X1,5	9/16"	12	19	10	14	26	17	315	4568	L
QME12LMOU08.1	18X1,5	3/4"	12	19	11	14	26	18	315	4568	L
QME15LMOU08.1	22X1,5	3/4"	15	22	11	17	26	18	315	4568	L
QME15LMOU10.1	22X1,5	7/8"	15	22	12,7	17	26,3	19,7	315	4568	L
QME18LMOU10.1	26X1,5	7/8"	18	27	12,7	17	32,3	20,2	315	4568	L
QME18LMOU12.1	26X1,5	1.1/16"	18	27	15	18	32,5	22,5	315	4568	L
QME22LMOU12.1	30X2	1.1/16"	22	27	15	19,5	35	22,5	160	2320	L
QME28LMOU16.1	36X2	1.5/16"	28	33	15	23	37	22,5	160	2320	L
QME35LMOU20.1	45X2	1.5/8"	35	41	15	27	39	25,5	160	2320	L
QME42LMOU24.1	52X2	1.7/8"	42	48	15	26	39	26	160	2320	L
QME06SMOU04.1	14X1,5	7/16"	6	14	9	11	21	16	400	5801	S
QME08SMOU06.1	16X1,5	9/16"	8	14	10	13	23	17	400	5801	S
QME10SMOU06.1	18X1,5	9/16"	10	19	10	13	23	17,5	400	5801	S
QME12SMOU08.1	20X1,5	3/4"	12	19	11	17	25	18,5	400	5801	S
QME14SMOU10.1	22X1,5	7/8"	14	22	12,7	16	26,3	20,7	400	5801	S
QME16SMOU10.1	24X1,5	7/8"	16	27	12,7	16	32,3	21,2	400	5801	S
QME20SMOU12.1	30X2	1.1/16"	20	27	15	19	35	25,5	400	5801	S
QME25SMOU16.1	36X2	1.5/16"	25	33	15	22	37	27	400	5801	S
QME30SMOU20.1	42X2	1.5/8"	30	41	15	24	39	28,5	250	3626	S
QME38SMOU24.1	52X2	1.7/8"	38	48	15	24	39	31	250	3626	S

DIN MALE BANJO ELBOW - BSPP

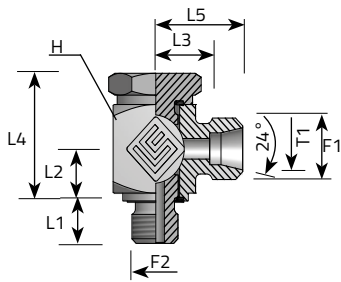

GOMITO 90° ORIENTABILE MASHIO DIN – BULLONE FORATO GAS CILINDRICO

EQUERRE ORIENTABLE ARTICULÉE DIN/BSPP

DROSSELFREIE SCHWENKVERSCHRAUBUNG 90° – DIN 24° MIT HOHLSCHRAUBE AGR-Z

RACOR EN CODO ORIENTABLE SIN ESTRANGULACIÓN DIN/BSPP

F1 Metrisch, Metrico, Metric, Métrique, Métrico

F2 Zylinder-Gasgewinde, Gas cilindrico, BSPP, Gaz cylindrique, Gas cilíndrica

Code	Thread		Dimensions							Pressure		Series
	F1	F2	T1	H	L1	L2	L3	L4	L5	Bar	Psi	
			mm	mm	mm	mm	mm	mm	mm			
LME06LBFG02.1	12X1,5	1/8"	6	17	8	10,5	12	18,5	19	315	4568	L
LME08LBFG04.1	14X1,5	1/4"	8	22	12	14	14,5	25	21,5	315	4568	L
LME10LBFG04.1	16X1,5	1/4"	10	22	12	14	15,5	25	22,5	315	4568	L
LME12LBFG06.1	18X1,5	3/8"	12	27	12	16,5	18	30	25	315	4568	L
LME15LBFG08.1	22X1,5	1/2"	15	32	14	21,5	22	37,5	29	315	4568	L
LME18LBFG08.1	26X1,5	1/2"	18	32	14	21,5	21,5	37,5	29	315	4568	L
LME22LBFG12.1	30X2	3/4"	22	41	16	24	26,5	44	34	160	2320	L
LME28LBFG16.1	36X2	1"	28	50	18	30,5	31	55,5	38,5	160	2320	L
LME35LBFG20.1	45X2	1.1/4"	35	60	20	35,5	35	65,5	45,5	160	2320	L
LME42LBFG24.1	52X2	1.1/2"	42	70	22	40,5	39,5	75,5	50,5	160	2320	L
LME06SBFG04.1	14X1,5	1/4"	6	22	12	14	16,5	25	23,5	630	9137	S
LME08SBFG04.1	16X1,5	1/4"	8	22	12	14	16,5	25	23,5	630	9137	S
LME10SBFG06.1	18X1,5	3/8"	10	27	12	16,5	18,5	30	26	630	9137	S
LME12SBFG06.1	20X1,5	3/8"	12	27	12	16,5	18,5	30	26	630	9137	S
LME14SBFG08.1	22X1,5	1/2"	14	32	14	21,5	23	37,5	31	630	9137	S
LME16SBFG08.1	24X1,5	1/2"	16	32	14	21,5	22,5	37,5	31	400	5801	S
LME20SBFG12.1	30X2	3/4"	20	41	16	24	25,5	44	36	400	5801	S
LME25SBFG16.1	36X2	1"	25	50	18	30,5	31,5	55,5	43,5	400	5801	S
LME30SBFG20.1	42X2	1.1/4"	30	60	20	35,5	36	65,5	49,5	400	5801	S
LME38SBFG24.1	52X2	1.1/2"	38	70	22	40,5	40,5	75,5	56,5	315	4568	S

DIN MALE BANJO ELBOW - METRIC

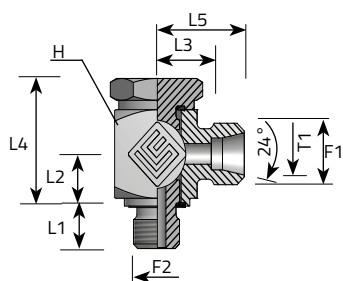

GOMITO 90° ORIENTABILE MASCHIO DIN – BULLONE FORATO METRICO
 EQUERRE ORIENTABILE ARTICULÉE DIN / MÉTRIQUE
 DROSSELFREIE SCHWENKVERSCHRAUBUNG 90° – DIN 24° MIT
 HOHLSCHRAUBE AGM-Z
 RACOR EN CODO ORIENTABLE SIN ESTRANGULACIÓN DIN / MÉTRICO

F1 Metrisch, Metrico, Metric, Métrique, Métrico

F2 Metrisch, Metrico, Metric, Métrique, Métrico

Code	Thread		Dimensions							Pressure		Series
	F1	F2	T1	H	L1	L2	L3	L4	L5	Bar	Psi	L/S
mm												
LME06LBFM10.1	12X1,5	10X1	6	17	8	10,5	12	18,5	19	315	4568	L
LME08LBFM12.1	14X1,5	12X1,5	8	22	12	14	14,5	25	21,5	315	4568	L
LME10LBFM14.1	16X1,5	14X1,5	10	22	12	14	15,5	25	22,5	315	4568	L
LME12LBFM16.1	18X1,5	16X1,5	12	27	12	16,5	18	30	25	315	4568	L
LME15LBFM18.1	22X1,5	18X1,5	15	32	12	18,5	22	33,5	29	315	4568	L
LME18LBFM22.1	26X1,5	22X1,5	18	32	14	21,5	21,5	37,5	29	315	4568	L
LME22LBFM26.1	30X2	26X1,5	22	41	16	24	26,5	44	34	160	2320	L
LME28LBFM33.1	36X2	33X2	28	50	18	30,5	31	55,5	38,5	160	2320	L
LME35LBFM42.1	45X2	42X2	35	60	20	35,5	35	65,5	45,5	160	2320	L
LME42LBFM48.1	52X2	48X2	42	70	22	40,5	39,5	75,5	50,5	160	2320	L
LME06SBFM12.1	14X1,5	12X1,5	6	22	12	14	16,5	25	23,5	630	9137	S
LME08SBFM14.1	16X1,5	14X1,5	8	22	12	14	16,5	25	23,5	630	9137	S
LME10SBFM16.1	18X1,5	16X1,5	10	27	12	16,5	18,5	30	26	630	9137	S
LME12SBFM18.1	20X1,5	18X1,5	12	32	12	18,5	21,5	33,5	29	630	9137	S
LME14SBFM20.1	22X1,5	20X1,5	14	32	14	20	23	36	31	630	9137	S
LME16SBFM22.1	24X1,5	22X1,5	16	32	14	21,5	22,5	37,5	31	400	5801	S
LME20SBFM27.1	30X2	27X2	20	41	16	24	25,5	44	36	400	5801	S
LME25SBFM33.1	36X2	33X2	25	50	18	30,5	31,5	55,5	43,5	400	5801	S
LME30SBFM42.1	42X2	42X2	30	60	20	35,5	36	65,5	49,5	400	5801	S
LME38SBFM48.1	52X2	48X2	38	70	22	40,5	40,5	75,5	56,5	315	4568	S

DIN MALE BANJO TEE - BSPP

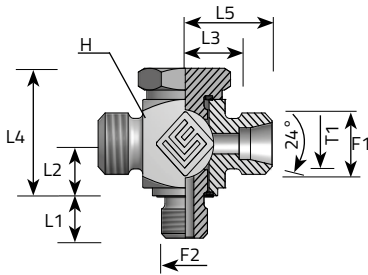

T ORIENTABILE MASCHIO DIN – BULLONE FORATO GAS CILINDRICO AL PIEDE

TÉ ORIENTABLE BANJO DIN/DIN/BSPP

T-DROSSELFREIE SCHWENKVERSCHRAUBUNG – 2 X DIN 24° MIT HOHLSCHRAUBE AGR-Z

RACOR EN T ORIENTABLE SIN ESTRANGULACIÓN

F1 Metrisch, Metrico, Metric, Métrique, Métrico

F2 Zylinder-Gasgewinde, Gas cilindrico, BSPP, Gaz cylindrique, Gas cilíndrica

Code	Thread		Dimensions							Pressure		Series
	F1	F2	T1	H	L1	L2	L3	L4	L5	Bar	Psi	L/S
			mm	mm	mm	mm	mm	mm	mm			
TME06LBFG02P.1	12X1,5	1/8"	6	17	8	10,5	12	18,5	19	315	4568	L
TME08LBFG04P.1	14X1,5	1/4"	8	22	12	14	14,5	25	21,5	315	4568	L
TME10LBFG04P.1	16X1,5	1/4"	10	22	12	14	15,5	25	22,5	315	4568	L
TME12LBFG06P.1	18X1,5	3/8"	12	27	12	16,5	18	30	25	315	4568	L
TME15LBFG08P.1	22X1,5	1/2"	15	32	14	21,5	22	37,5	29	315	4568	L
TME18LBFG08P.1	26X1,5	1/2"	18	32	14	21,5	21,5	37,5	29	315	4568	L
TME22LBFG12P.1	30X2	3/4"	22	41	16	24	26,5	44	34	160	2320	L
TME28LBFG16P.1	36X2	1"	28	50	18	30,5	31	55,5	38,5	160	2320	L
TME35LBFG20P.1	45X2	1.1/4"	35	60	20	35,5	35	65,5	45,5	160	2320	L
TME42LBFG24P.1	52X2	1.1/2"	42	70	22	40,5	39,5	75,5	50,5	160	2320	L
TME06SBFG04P.1	14X1,5	1/4"	6	22	12	14	16,5	25	23,5	630	9137	S
TME08SBFG04P.1	16X1,5	1/4"	8	22	12	12	16,5	25	23,5	630	9137	S
TME10SBFG06P.1	18X1,5	3/8"	10	27	12	16,5	18,5	30	26	630	9137	S
TME12SBFG06P.1	20X1,5	3/8"	12	27	12	16,5	18,5	30	26	630	9137	S
TME14SBFG08P.1	22X1,5	1/2"	14	32	14	21,5	23	37,5	31	630	9137	S
TME16SBFG08P.1	24X1,5	1/2"	16	32	4	21,5	22,5	37,5	31	400	5801	S
TME20SBFG12P.1	30X2	3/4"	20	41	16	24	25,5	44	36	400	5801	S
TME25SBFG16P.1	36X2	1"	25	50	18	30,5	31,5	55,5	43,5	400	5801	S
TME30SBFG20P.1	42X2	1.1/4"	30	60	20	35,5	36	65,5	49,5	400	5801	S
TME38SBFG24P.1	52X2	1.1/2"	38	70	22	40,5	40,5	75,5	56,5	315	4568	S

DIN MALE BANJO TEE - METRIC

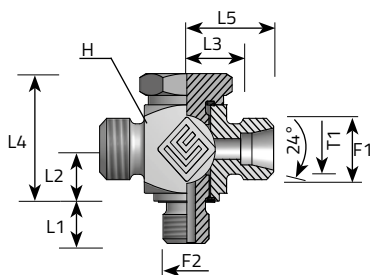

T ORIENTABILE MASCHIO DIN – BULLONE FORATO METRICO AL PIEDE
 TÉ ORIENTABLE BANJO DIN/DIN/MÉTRIQUE
 T-DROSSELFREIE SCHWENKVERSCHRAUBUNG – 2 X DIN 24° MIT
 HOHLSCHRAUBE AGM-Z
 RACOR EN T ORIENTABLE SIN ESTRANGULACION DIN/DIN/MÉTRICO

F1 Metrisch, Metrico, Metric, Métrique, Métrico

F2 Metrisch, Metrico, Metric, Métrique, Métrico

Code	Thread		Dimensions							Pressure		Series
	F1	F2	T1	H	L1	L2	L3	L4	L5	Bar	Psi	
			mm	mm	mm	mm	mm	mm	mm			
TME06LBFM10P.1	12X1,5	10X1	6	17	8	10,5	12	18,5	19	315	4568	L
TME08LBFM12P.1	14X1,5	12X1,5	8	22	12	14	14,5	25	21,5	315	4568	L
TME10LBFM14P.1	16X1,5	14X1,5	10	22	12	14	15,5	25	22,5	315	4568	L
TME12LBFM16P.1	18X1,5	16X1,5	12	27	12	16,5	18	30	25	315	4568	L
TME15LBFM18P.1	22X1,5	18X1,5	15	32	12	18,5	22	33,5	29	315	4568	L
TME18LBFM22P.1	26X1,5	22X1,5	18	32	14	21,5	21,5	37,5	29	315	4568	L
TME22LBFM26P.1	30X2	26X1,5	22	41	16	24	26,5	44	34	160	2320	L
TME28LBFM33P.1	36X2	33X2	28	50	18	30,5	31	55,5	38,5	160	2320	L
TME35LBFM42P.1	45X2	42X2	35	60	20	35,5	35	65,5	45,5	160	2320	L
TME42LBFM48P.1	52X2	48X2	42	70	22	40,5	39,5	75,5	50,5	160	2320	L
TME06SBFM12P.1	14X1,5	12X1,5	6	22	12	14	16,5	25	23,5	630	9137	S
TME08SBFM14P.1	16X1,5	14X1,5	8	22	12	14	16,5	25	23,5	630	9137	S
TME10SBFM16P.1	18X1,5	16X1,5	10	27	12	16,5	18,5	30	26	630	9137	S
TME12SBFM18P.1	20X1,5	18X1,5	12	32	12	18,5	21,5	33,5	29	630	9137	S
TME14SBFM20P.1	22X1,5	20X1,5	14	32	14	20	23	36	31	630	9137	S
TME16SBFM22P.1	24X1,5	22X1,5	16	32	14	21,5	22,5	37,5	31	400	5801	S
TME20SBFM27P.1	30X2	27X2	20	41	16	24	25,5	44	36	400	5801	S
TME25SBFM33P.1	36X2	33X2	25	50	18	30,5	31,5	55,5	43,5	400	5801	S
TME30SBFM42P.1	42X2	42X2	30	60	20	35,5	36	65,5	49,5	400	5801	S
TME38SBFM48P.1	52X2	48X2	38	70	22	40,5	40,5	75,5	56,5	315	4568	S

WELDING BOSS

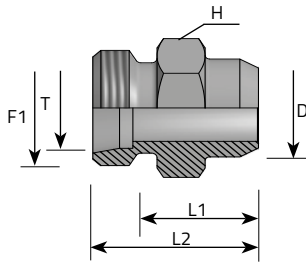

ADATTATORE DIRITTO MASCHIO DIN ESTREMITÀ A SALDARE
UNION SIMPLE À SOUDER
 GERADE ANSCHWEISSVERSCHRÄUBUNG – METRISCH 24°
 RACOR RECTO PARA SOLDAR

F1 Metrisch, Metrico, Metric, Métrique, Métrico

Code	Thread	Dimensions					Pressure		Series
		T1	H	L1	L2	D	Bar	Psi	
	F1	mm	mm	mm	mm	mm			
AME06LW.1	12X1,5	6	12	14	21	10	315	4568	L
AME08LW.1	14X1,5	8	14	16	23	12	315	4568	L
AME10LW.1	16X1,5	10	17	18	25	14	315	4568	L
AME12LW.1	18X1,5	12	19	18	25	16	315	4568	L
AME15LW.1	22X1,5	15	22	22	29	19	315	4568	L
AME18LW.1	26X1,5	18	27	23,5	31	22	315	4568	L
AME22LW.1	30X2	22	32	28,5	36	27	160	2320	L
AME28LW.1	36X2	28	41	30,5	38	32	160	2320	L
AME35LW.1	45X2	35	46	32,5	43	40	160	2320	L
AME42LW.1	52X2	42	55	35	46	46	160	2320	L
AME06SW.1	14X1,5	6	14	19	26	11	630	9137	S
AME08SW.1	16X1,5	8	17	21	28	13	630	9137	S
AME10SW.1	18X1,5	10	19	22,5	30	15	630	9137	S
AME12SW.1	20X1,5	12	22	24,5	32	17	630	9137	S
AME14SW.1	22X1,5	14	24	27	35	19	630	9137	S
AME16SW.1	24X1,5	16	27	26,5	35	21	400	5801	S
AME20SW.1	30X2	20	32	29,5	40	26	400	5801	S
AME25SW.1	36X2	25	41	32	44	31	400	5801	S
AME30SW.1	42X2	30	46	35,5	49	36	400	5801	S
AME38SW.1	52X2	38	55	38	54	44	315	4568	S

DIN WELDING NIPPLE (1)

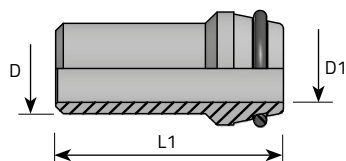

OGIVA A SALDARE CON O-RING DIN 3865 A – ISO 8434-4
EMBOUT À SOUDER AVEC O-RING
 SCHWEISSNIPPEL MIT O-RING-ABDICHTUNG DIN 3865 A – ISO 8434-4
 – 24° KEGEL
BOQUILLA PARA SOLDAR DIN 3865 A – ISO 8434-4 CON JUNTA TÓRICA

Code	Thread	Dimensions					Pressure		Series
		T1	S	D1	D	L1	Bar	Psi	
		mm	mm	mm	mm	mm			
TLS06W		6	1.75	2.5	6	31	630	9137	L/S
TLS08W		8	2	4	8	31	630	9137	L/S
TLS10W		10	1.5	7	10	32.5	315	4568	L/S
TLS10WX2		10	2	6	10	32.5	400	5801	L/S
TLS12W		12	1.5	9	12	32.5	315	4568	L/S
TLS12WX2		12	2	8	12	32.5	400	5801	L/S
TLS12WX2.5		12	2.5	7	12	32.5	630	9137	L/S
TL15W		15	2.5	10	15	34	315	4568	L
TL18W		18	2.5	13	18	35.5	315	4568	L
TL22W		22	2.5	17	22	38.5	160	2320	L
TL28W		28	2.5	23	28	41.5	160	2320	L
TL35W		35	3	29	35	47.5	160	2320	L
TL42W		42	3	36	42	47.5	160	2320	L
TS14W		14	3	8	14	38.5	400	5801	S
TS16W		16	2	12	16	39	250	3626	S
TS16WX2.5		16	2.5	11	16	39	315	4568	S
TS16WX3		16	3	10	16	39	400	5801	S
TS20W		20	2.5	15	20	45	250	3626	S
TS20WX3		20	3	14	20	45	315	4568	S
TS20WX4		20	4	12	20	45	400	5801	S

DIN WELDING NIPPLE (2)

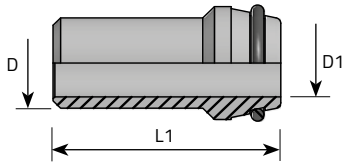

OGIVA A SALDARE CON O-RING DIN 3865 A – ISO 8434-4
 EMBOUT À SOUDER AVEC O-RING
 SCHWEISSNIPPEL MIT O-RING-ABDICHTUNG DIN 3865 A – ISO 8434-4
 – 24° KEGEL
 BOQUILLA PARA SOLDAR DIN 3865 A – ISO 8434-4 CON JUNTA TÓRICA

Code	Thread	Dimensions					Pressure		Series
		T1	S	D1	D	L1	Bar	Psi	
		mm	mm	mm	mm	mm			
TS25W		25	3	19	25	49.5	250	3626	S
TS25WX4		25	4	17	25	49.5	315	4568	S
TS25WX5		25	5	15	25	49.5	400	5801	S
TS30W		30	3	24	30	52	160	2320	S
TS30WX4		30	4	22	30	52	250	3626	S
TS30WX5		30	5	20	30	52	315	4568	S
TS30WX6		30	6	18	30	52	315	4568	S
TS38W		38	3	32	38	56.5	160	2320	S
TS38WX5		38	5	28	38	56.5	250	3626	S
TS38WX6		38	6	26	38	56.5	315	4568	S
TS38WX8		38	8	22	38	56.5	315	4568	S

DIN MALE-WELDING BULKHEAD CONNECION

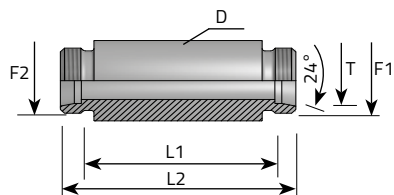

PROLUNGA SALDABILE MASCHIO DIN – MASCHIO DIN
 UNION DOUBLE PASSE CLOISON À SOUDER
 EINSCHWEISS-SCHOTTVERSCHRAUBUNG – METRISCH 24° / M. 24°
 RACOR PASATABIQUE PARA SOLDAR

F1 Metrisch, Metrico, Metric, Métrique, Métrico

F2 Metrisch, Metrico, Metric, Métrique, Métrico

Code	Thread	Dimensions				Pressure		Series
		F1	T	D	L1	L2	Bar	
		mm	mm	mm	mm			
APME06LW.1	12X1,5	6	18	56	70	315	4568	L
APME08LW.1	14X1,5	8	20	56	70	315	4568	L
APME10LW.1	16X1,5	10	22	58	72	315	4568	L
APME12LW.1	18X1,5	12	25	58	72	315	4568	L
APME15LW.1	22X1,5	15	28	70	84	315	4568	L
APME18LW.1	26X1,5	18	32	69	84	315	4568	L
APME22LW.1	30X2	22	36	73	88	160	2320	L
APME28LW.1	36X2	28	40	73	88	160	2320	L
APME35LW.1	45X2	35	50	71	92	160	2320	L
APME42LW.1	52X2	42	60	70	92	160	2320	L
APME06SW.1	14X1,5	6	20	60	74	630	9137	S
APME08SW.1	16X1,5	8	22	60	74	630	9137	S
APME10SW.1	18X1,5	10	25	59	74	630	9137	S
APME12SW.1	20X1,5	12	28	59	74	630	9137	S
APME14SW.1	22X1,5	14	30	72	88	630	9137	S
APME16SW.1	24X1,5	16	35	71	88	400	5801	S
APME20SW.1	30X2	20	38	71	92	400	5801	S
APME25SW.1	36X2	25	45	72	96	400	5801	S
APME30SW.1	42X2	30	50	73	100	400	5801	S
APME38SW.1	52X2	38	60	72	104	315	4568	S

DIN MALE WELDING ELBOW

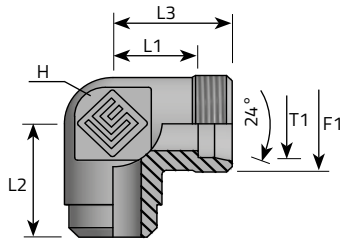

GOMITO 90° MASCHIO DIN – ESTREMITÀ A SALDARE
 COUDE MÂLE A SOUDER
 WINKEL-EINSCHRAUBVERSCHRAUBUNG 90° – 24° METRISCH /
 SCHWEISSNIPPEL
 RACOR EN CODO PARA SOLDAR

F1 Metrisch, Metrico, Metric, Métrique, Métrico

Code	Thread	Dimensions							Pressure		Series
		F1	T1	H	L1	L2	L3	D	L5	Bar	
LME06LW.1	12X1,5	6	12	12	19	19	10	315	4568	L	
LME08LW.1	14X1,5	8	12	14	21	21	12	315	4568	L	
LME10LW.1	16X1,5	10	14	15	22	22	14	315	4568	L	
LME12LW.1	18X1,5	12	17	17	24	24	16	315	4568	L	
LME15LW.1	22X1,5	15	19	21	28	28	19	315	4568	L	
LME18LW.1	26X1,5	18	24	23,5	31	31	22	315	4568	L	
LME22LW.1	30X2	22	27	27,5	35	35	27	160	2320	L	
LME28LW.1	36X2	28	36	30,5	38	38	32	160	2320	L	
LME35LW.1	45X2	35	41	34,5	45	45	40	160	2320	L	
LME42LW.1	52X2	42	50	40	51	51	46	160	2320	L	
LME06SW.1	14X1,5	6	12	16	23	23	11	630	9137	S	
LME08SW.1	16X1,5	8	14	17	24	24	13	630	9137	S	
LME10SW.1	18X1,5	10	17	17,5	25	25	15	630	9137	S	
LME12SW.1	20X1,5	12	17	21,5	29	29	17	630	9137	S	
LME14SW.1	22X1,5	14	19	22	30	30	19	630	9137	S	
LME16SW.1	24X1,5	16	24	24,5	33	33	21	400	5801	S	
LME20SW.1	30X2	20	27	26,5	37	37	26	400	5801	S	
LME25SW.1	36X2	25	36	30	42	42	31	400	5801	S	
LME30SW.1	42X2	30	41	35,5	49	49	36	400	5801	S	
LME38SW.1	52X2	38	50	41	57	57	44	315	4568	S	

DIN CONNECTOR BSPP MALE-BSPP FEMALE

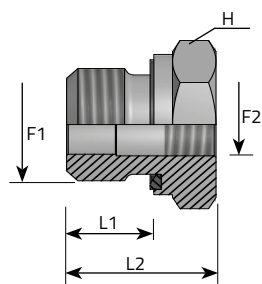

RIDUZIONE MASCHIO GAS CILINDRICO FORMA E DIN 3852 – F. FISSA GAS CILINDRICA

INTERMÉDIAIRE DE RÉDUCTION MÂLE-FEMELLE JOINT EN CAOUTCHOUC
GEWINDEREDUZIERUNG MIT GUMMIDICHTUNG AGR-Z / DKR-Z
REDUCCIÓN CON ROSCA MACHO-HEMBRA FIJA CON JUNTA TÓRICA

F1 Zylinder-Gasgewinde, Gas cilindrico, BSPP, Gaz cylindrique,
Gas cilíndrica

F2 Zylinder-Gasgewinde, Gas cilindrico, BSPP, Gaz cylindrique,
Gas cilíndrica

Code	Thread		Dimensions			Pressure		Series
	F1	F2	H	L1	L2	Bar	Psi	
			mm	mm	mm	L/S		
ARMG06ELFFG02	3/8"	1/8"	22	12	10,5	315	4568	
ARMG08ELFFG02	1/2"	1/8"	27	14	10	315	4568	
ARMG08ELFFG04	1/2"	1/4"	27	14	10	315	4568	
ARMG12ELFFG04	3/4"	1/4"	32	16	10	315	4568	
ARMG12ELFFG06	3/4"	3/8"	32	16	10	315	4568	
ARMG16ELFFG04	1"	1/4"	41	18	11	315	4568	
ARMG16ELFFG06	1"	3/8"	41	18	11	160	2320	
ARMG16ELFFG08	1"	1/2"	41	18	11	160	2320	
ARMG20ELFFG08	1.1/4"	1/2"	50	20	12	160	2320	
ARMG20ELFFG12	1.1/4"	3/4"	50	20	12	160	2320	
ARMG24ELFFG08	1.1/2"	1/2"	55	22	14	630	9137	
ARMG24ELFFG12	1.1/2"	3/4"	55	22	14	630	9137	
ARMG24ELFFG16	1.1/2"	1"	55	22	14	630	9137	

DIN CONNECTOR BSPP MALE-BSPP FEMALE

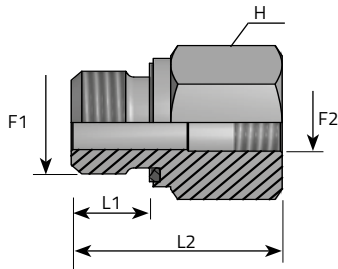

PROLUNGA MASCHIO GAS CILINDRICO FORMA E DIN 3852 – F. FISSA GAS CILINDRICA
 INTERMÉDIAIRE DE RÉDUCTION MÂLE-FEMELLE JOINT EN CAOUTCHOUC
 GEWINDEREDUZIERUNG UND VERLÄNGERUNG MIT GUMMIDICHTUNG – AGR-Z / DKR-Z
 REDUCCIÓN CON ROSCA MACHO-HEMBRA FIJA CON JUNTA TÓRICA

F1 Zylinder-Gasgewinde, Gas cilindrico, BSPP, Gaz cylindrique, Gas cilíndrica

F2 Zylinder-Gasgewinde, Gas cilindrico, BSPP, Gaz cylindrique, Gas cilíndrica

Code	Thread		Dimensions			Pressure		Series
	F1	F2	H	L1	L2	Bar	Psi	
			mm	mm	mm	L/S		
APMG02ELFFG04	1/8"	1/4"	19	8	23	630	9137	
APMG02ELFFG06	1/8"	3/8"	24	8	24	630	9137	
APMG04ELFFG02	1/4"	1/8"	19	12	16	630	9137	
APMG04ELFFG06	1/4"	3/8"	24	12	24	630	9137	
APMG04ELFFG08	1/4"	1/2"	30	12	28	630	9137	
APMG04ELFFG12	1/4"	3/4"	36	12	31	630	9137	
APMG06ELFFG04	3/8"	1/4"	22	12	24	630	9137	
APMG06ELFFG08	3/8"	1/2"	30	12	29	630	9137	
APMG06ELFFG12	3/8"	3/4"	36	12	32	400	5801	
APMG08ELFFG06	1/2"	3/8"	27	14	22	630	9137	
APMG08ELFFG12	1/2"	3/4"	36	14	32	400	5801	
APMG08ELFFG16	1/2"	1"	41	14	35	400	5801	
APMG08ELFFG20	1/2"	1.1/4"	55	14	39	400	5801	
APMG12ELFFG08	3/4"	1/2"	32	16	26	400	5801	
APMG12ELFFG16	3/4"	1"	41	16	35	400	5801	
APMG12ELFFG20	3/4"	1.1/4"	55	16	39	400	5801	
APMG12ELFFG24	3/4"	1.1/2"	60	16	41	315	4568	
APMG16ELFFG12	1"	3/4"	41	18	29	400	5801	
APMG16ELFFG20	1"	1.1/4"	55	18	39	400	5801	
APMG16ELFFG24	1"	1.1/2"	60	18	41	315	4568	
APMG20ELFFG16	1.1/4"	1"	50	20	31	400	5801	
APMG20ELFFG24	1.1/4"	1.1/2"	60	20	40	315	4568	
APMG24ELFFG20	1.1/2"	1.1/4"	50	22	46	315	4568	

DIN 24° BLACKING PLUG

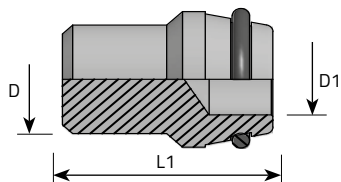

TAPPO FEMMINA GIREVOLE CONO A 24°
BOUCHON DE FERMETURE AVEC O-RING DIN 24°
VERSCHLUSSKEGEL MIT O-RING DIN 24°
TAPÓN DE CIERRE CON JUNTA TÓRICA

Code	Thread	Dimensions			Pressure		Series
		T1	D	L1	Bar	Psi	
		mm	mm	mm			
ATFGE06L		6	6	18,5	315	4568	L
ATFGE08L		8	8	18,5	315	4568	L
ATFGE10L		10	10	20	315	4568	L
ATFGE12L		12	12	20,5	315	4568	L
ATFGE15L		15	15	20,5	315	4568	L
ATFGE18L		18	18	22,5	315	4568	L
ATFGE22L		22	22	25	160	2320	L
ATFGE28L		28	28	25,5	160	2320	L
ATFGE35L		35	35	30	160	2320	L
ATFGE42L		42	42	30	160	2320	L
ATFGE06S		6	6	18,5	630	9137	S
ATFGE08S		8	8	18,5	630	9137	S
ATFGE10S		10	10	20	630	9137	S
ATFGE12S		12	12	20,5	630	9137	S
ATFGE14S		14	14	22,5	630	9137	S
ATFGE16S		16	16	23,5	400	5801	S
ATFGE20S		20	20	28,5	400	5801	S
ATFGE25S		25	25	29	400	5801	S
ATFGE30S		30	30	30,5	400	5801	S
ATFGE38S		38	38	33	315	4568	S

DIN 24° PIPE PLUG

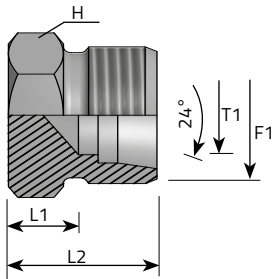

TAPPO MASCHIO A 24°
BOUCHON DE FERMETURE TUBES DIN 24°
ROHRVERSCHLUSSDECKEL DIN 24° – METRISCH
TAPÓN MACHO DIN 24°

F1 Metrisch, Metrico, Metric, Métrique, Métrico

Code	Thread	Dimensions				Pressure		Series	
		F1	T1	H	L1	L2	Bar		Psi
			mm	mm	mm	mm			
ATME06L.1	12X1,5	6	12	7	13	315	4568	L	
ATME08L.1	14X1,5	8	14	8	14	315	4568	L	
ATME10L.1	16X1,5	10	17	9	15	315	4568	L	
ATME12L.1	18X1,5	12	19	10	16	315	4568	L	
ATME15L.1	22X1,5	15	24	11	17	315	4568	L	
ATME18L.1	26X1,5	18	27	11,5	19	315	4568	L	
ATME22L.1	30X2	22	32	13,5	21	160	2320	L	
ATME28L.1	36X2	28	41	14,5	22	160	2320	L	
ATME35L.1	45X2	35	46	14,5	25	160	2320	L	
ATME42L.1	52X2	42	55	16	27	160	2320	L	
ATME06S.1	14X1,5	6	14	11	18	630	9137	S	
ATME08S.1	16X1,5	8	17	13	20	630	9137	S	
ATME10S.1	18X1,5	10	19	12,5	20	630	9137	S	
ATME12S.1	20X1,5	12	22	14,5	22	630	9137	S	
ATME14S.1	22X1,5	14	24	16	24	630	9137	S	
ATME16S.1	24X1,5	16	27	15,5	24	400	5801	S	
ATME20S.1	30X2	20	32	17,5	28	400	5801	S	
ATME25S.1	36X2	25	41	20	32	400	5801	S	
ATME30S.1	42X2	30	46	20,5	34	400	5801	S	
ATME38S.1	52X2	38	55	23	39	315	4568	S	

DIN INNER HEXAGON PLUG BSPP FORM E DIN 3852

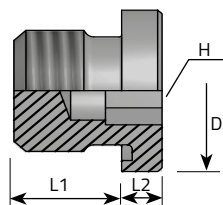

TAPPO MASCHIO METRICO FORMA E DIN 3852 CON ESAGONO INCASSATO
 VERSCHLUSSSTOPFEN MIT INNENSECHSKANT GUMMIDICHTUNG FORM E
 DIN 3852 – METRISCH-ZYLINDRISCH
 TAPÓN DE CIERRE ALLEN CON JUNTA TÓRICA FORMA E DIN 3852

F1 Metrisch, Metrico, Metric, Métrique, Métrico

Code	Thread	Dimensions				Pressure		Series
		H	L1	L2	D	Bar	Psi	
F1		mm	mm	mm	mm			
ATMM10ELX	10X1	5	8	4	14			
ATMM12ELX	12X1,5	6	12	5	17			
ATMM14ELX	14X1,5	6	12	5	19			
ATMM16ELX	16X1,5	8	12	5	22			
ATMM18ELX	18X1,5	8	12	5	24			
ATMM20ELX	20X1,5	10	14	5	26			
ATMM22ELX	22X1,5	10	14	5	27			
ATMM26ELX	26X1,5	12	16	5	32			
ATMM27ELX	27X2	12	16	5	32			
ATMM33ELX	33X2	17	16	6,5	40			
ATMM42ELX	42X2	22	16	6,5	50			
ATMM48ELX	48X2	24	16	6,5	55			

DIN INNER HEXAGON PLUG BSPP FORM E DIN 3852

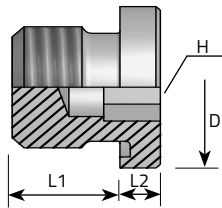

TAPPO MASCHIO GAS FORMA E DIN 3852 CON ESAGONO INCASSATO
 TAPPO MASCHIO METRICO FORMA E DIN 3852 CON ESAGONO INCASSATO
 VERSCHLUSSSTOPFEN MIT INNENSECHSKANT GUMMIDICHTUNG FORM E
 DIN 3852 – METRISCH-ZYLINDRISCH
 TAPÓN DE CIERRE ALLEN CON JUNTA TÓRICA FORMA E DIN 3852

F1 Zylinder-Gasgewinde, Gas cilindrico, BSPP, Gaz cylindrique,
 Gas cilindrica

Code	Thread	Dimensions				Pressure		Series
		H	L1	L2	D	Bar	Psi	
	F1	mm	mm	mm	mm			
ATMG02ELX	1/8"	5	8	4	14			
ATMG04ELX	1/4"	6	12	5	19			
ATMG06ELX	3/8"	8	12	5	22			
ATMG08ELX	1/2"	10	14	5	27			
ATMG12ELX	3/4"	12	16	5	32			
ATMG16ELX	1"	17	16	6,5	40			
ATMG20ELX	1.1/4"	22	16	6,5	50			
ATMG24ELX	1.1/2"	27	16	6,5	55			

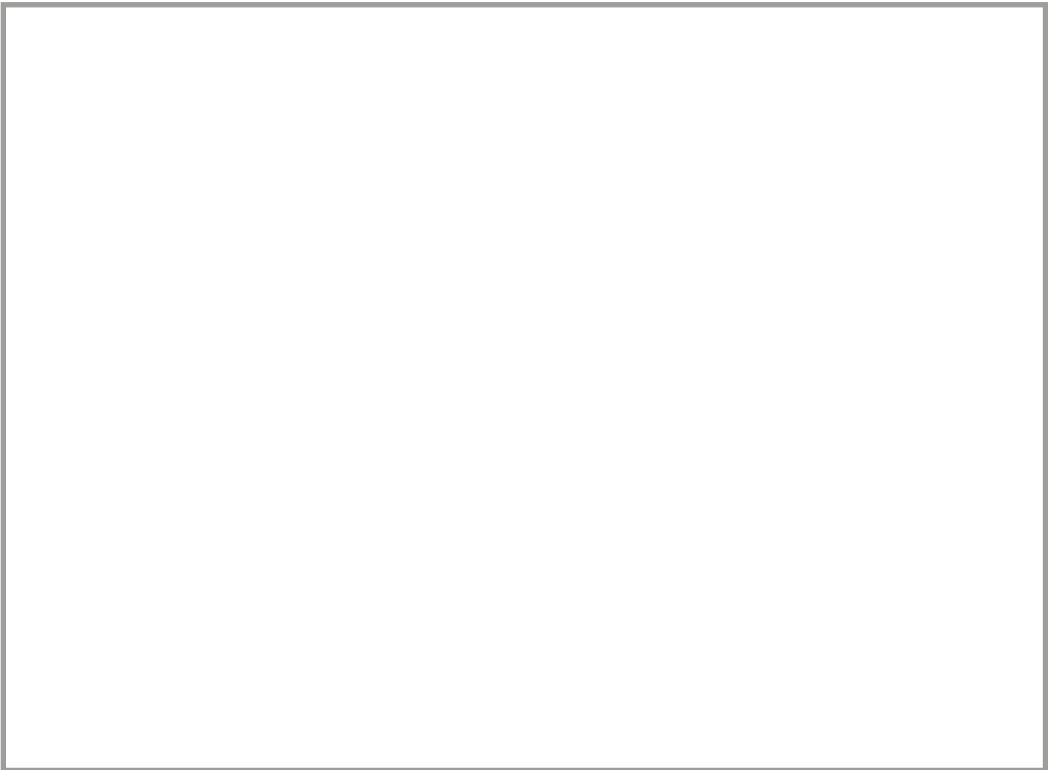

DIN 2353 24° a-2016 eu

Data reported in this catalogue are not binding.
Vitillo S.p.a. reserves the right to change specifications without notice.

I dati riportati nella seguente pubblicazione non sono vincolanti.
Vitillo S.p.a. si riserva di apportare modifiche senza preavviso.

Les données exposées dans ce catalogue ne sont pas contraignantes.
Vitillo s.p.a se réserve le droit d'apporter des modifications sans aucun préavis.

Die vorliegenden Angaben sind nicht bindend.
Vitillo S.p.a. behält sich technische Änderungen vor ohne Mitteilung.

Los datos referidos en la presente publicación son indicativos.
Vitillo S.p.a. se reserva el derecho de modificar las especificaciones sin aviso previo.